



# DP88A SIP DOOR PHONE QUICK INSTALLATION GUIDE

## Catalogue

1. Packing List	3
2. Material Specification	4
3. Installation	9
4. Get the device IP address	9
5. Door Access Configuration	9
6. Door Open Configuration	11

## DP88A Quick Installation Guide

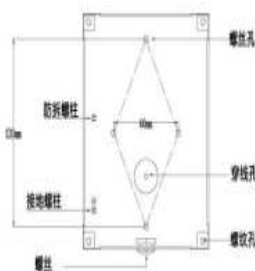
# 1. Packing List

DP88A Device	Installation diagram	Accessories	RFID Card
			

# 2. Material Specification

DP88A Device Dimension	285*120*38mm
------------------------	--------------

## Front Panel

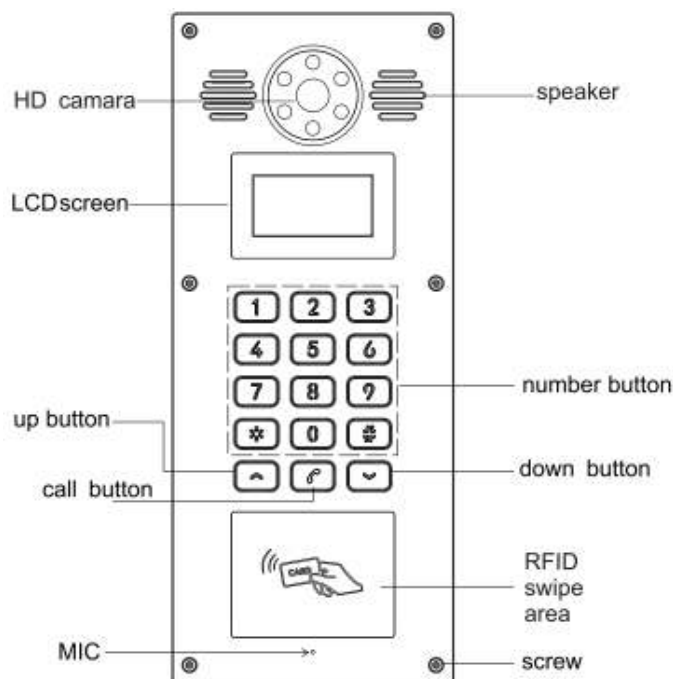

## Wiring Port Specification

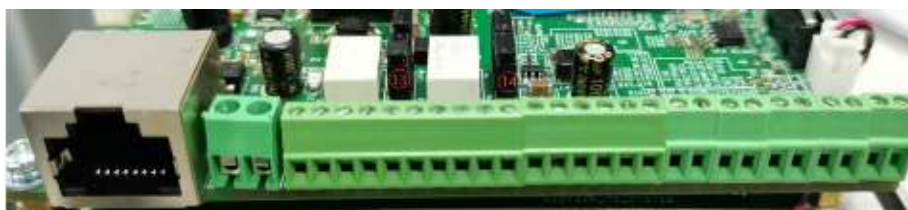

( Picture II )

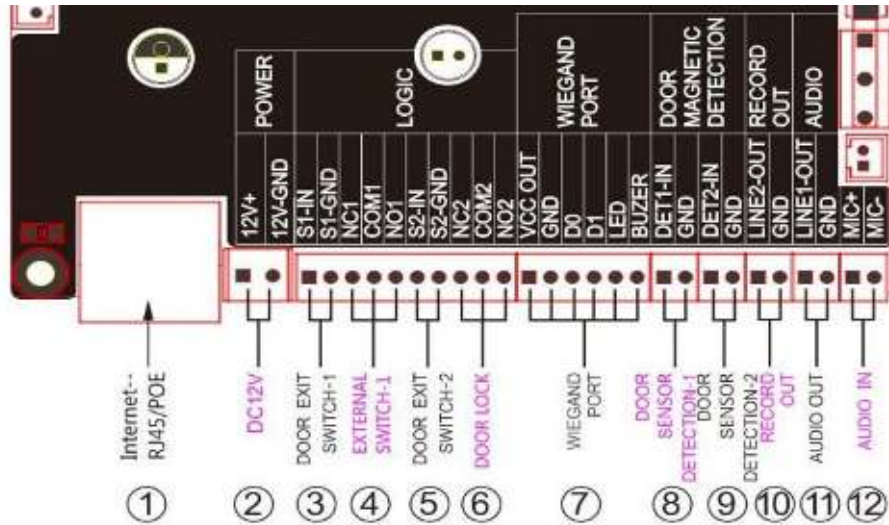

( Picture III )

Item	Description
1	Internet Port: Standard RJ45 port , 10/100M Adaptive , suggest use CAT5 or CAT5E line.
2	Power Adaptor : 12V/1A input , left port is “+” , right port is “-”
3、 5	Door Exit Switch : To connect indoor exit button
4、 6	External Switch/Door Lock : To connect door lock, alarm etc.
7	Wiegand Port: To connect wiegand card reader.
8、 9	Door sensor detection : to detect the door open/close status.
10	To mix device voice & remote call voice, then release them together. 1 port is for record, another port is for GND.
12	Audio Input: To connect a external audio signal.
13	JP1 jumper ( Picture II )
14	JP6 jumper ( Picture II )

### JP1, JP6 Jumper

Door lock control include 2 models (default is internal power supply), see as below,

**Internal power supply:** If electric lock starting current less than 500mA/12V, can use internal drive model, electric lock port is 12V DC output.

(Picture IV )

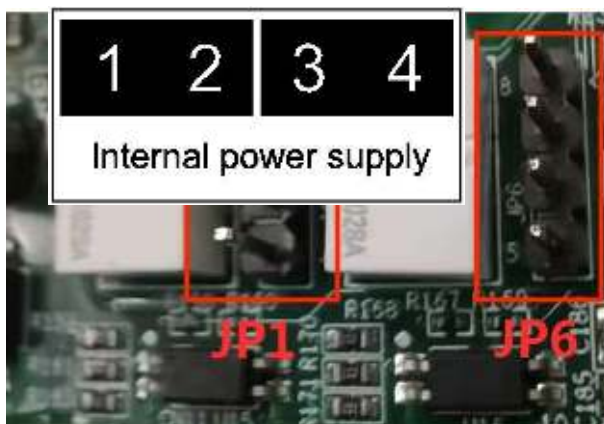

### Wiring Description



NO: Normal Open, working status electric lock is open ;

COM: Common port ;

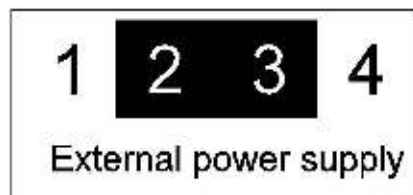
NC:

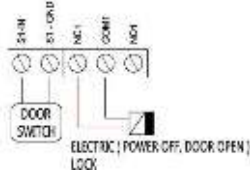

Normal Closed, working status electric lock is closed ;

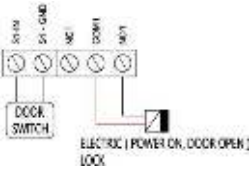
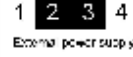
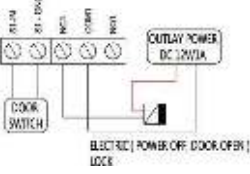
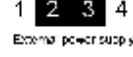
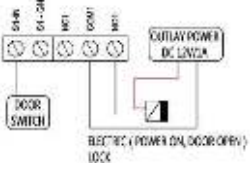
Power Supply Type		Electric Lock type		JP1 Jumper	Wiring Diagram
Internal	External	Power off, door open	Power on, door open		
√		√			
√			√		
	√	√			
	√		√		

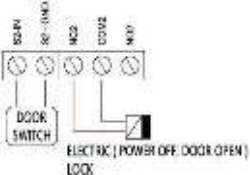
Power Supply Type		Electric Lock type		JP6 Jumper	Wiring Diagram
Internal	External	Power off, door open	Power on, door open		
√		√			

√			√	<p>1 2 3 4 Internal power supply</p>	
	√	√		<p>1 2 3 4 External power supply</p>	
	√		√	<p>1 2 3 4 External power supply</p>	

### 3. Installation

1. Drill 4 holes on the wall, space is 60\*120mm(DP88 space is 60\*180mm), insert Plastic expansion tube, use KA4\*30 screws to fix back panel on the wall. (see Picture V)
2. Use 4 pcs M3\*8 screws from the front panel to fix back panel(DP88 use 6 pcs screws).(Picture VI)

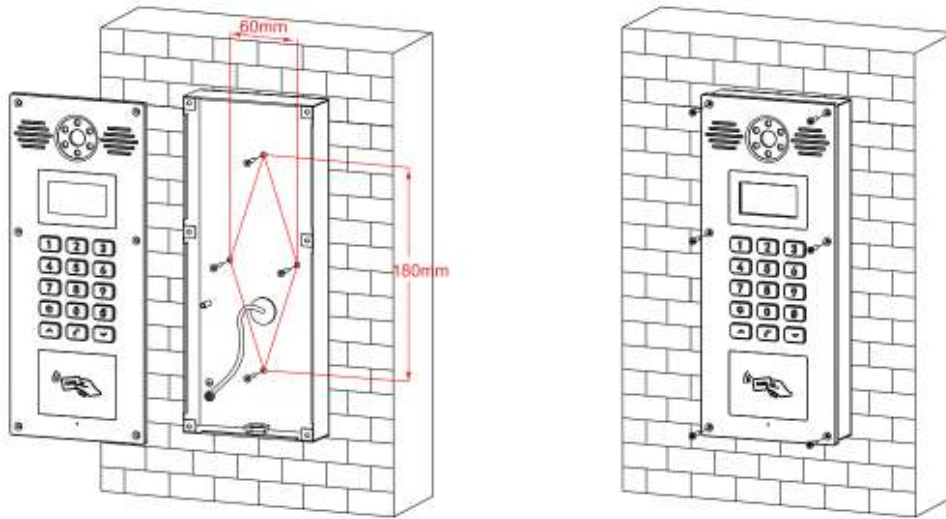

### 4. Get the device IP address

After device connect to the power supply, default way to get IP address is DHCP. Press “963 + call button”, the device voice will read IP address, then also device LCD will display IP address.

### 5. Door Access Configuration

#### Log in the Device Web GUI

To input the device IP on the web browser. (for example:[input http://172.28.4.131](http://172.28.4.131) ),and then entry the [log in interface](#), default account: admin, default password: admin )



## Configure SIP Account

To configure SIP account, Active, register name, username password , SIP server address & port, then submit.

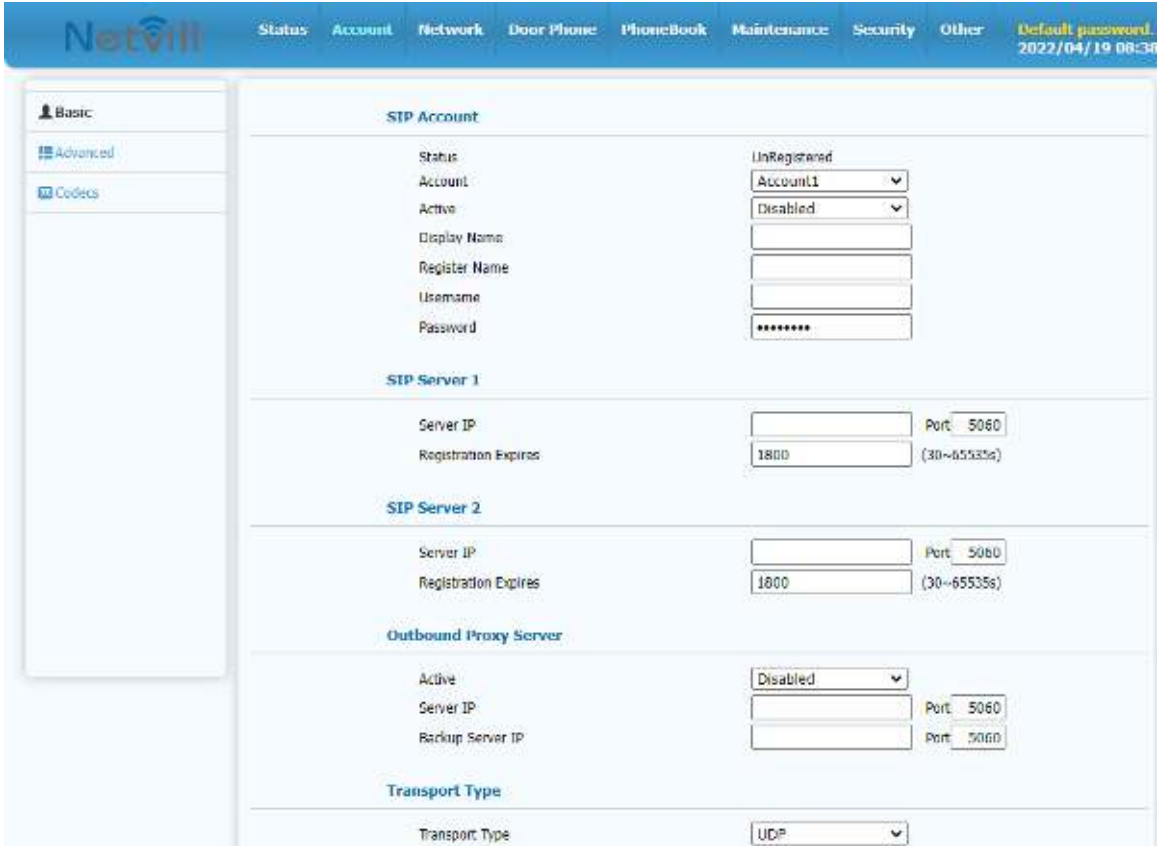

The screenshot displays the NetVill web interface for configuring a SIP account. The interface is organized into several sections:

- SIP Account:** This section contains fields for Status (LnRegistered), Account (Account1), Active (Disabled), Display Name, Register Name, Username, and Password (masked with asterisks).
- SIP Server 1:** This section contains fields for Server IP, Port (5060), and Registration Expires (1800).
- SIP Server 2:** This section contains fields for Server IP, Port (5060), and Registration Expires (1800).
- Outbound Proxy Server:** This section contains fields for Active (Disabled), Server IP, Port (5060), and Backup Server IP, Port (5060).
- Transport Type:** This section contains a field for Transport Type (UDP).

## To configure Door Access Parameter

1. In "Access- Open Door by DTMF Code" to configure DTMF code of indoor station.
2. In "Access- Access Card" to add RFID card & password.
3. In "Access- Open Door By HTTP" to configure username & password of HTTP door open.

The screenshot shows the NetVill web interface with the following sections:

- Open Door By DTMF Code:**
  - Active: Enabled
  - Door 1: 1
  - Door 2: 0
  - All Doors: 3
- Identify Door Phone:**
  - Identify: [Submit]
- Access Card:**
  - Door opening method: Password
  - Search By Room Number: [Input Field] [Search] [Cancel]
- Table:**

Index	Room Number	Password	Type	Door Number	Register Time	Period	
							<input type="checkbox"/>
							<input type="checkbox"/>
							<input type="checkbox"/>
							<input type="checkbox"/>
							<input type="checkbox"/>
							<input type="checkbox"/>
							<input type="checkbox"/>
							<input type="checkbox"/>
							<input type="checkbox"/>
							<input type="checkbox"/>
- Card Register:**
  - Door Number: 182

### 6. Door Open Configuration

In "Door Phone- Basic" to configure Switch Model, and Card Reader Model.



- Basic
- Time&Date
- Call Feature
- Voice
- Ringtones
- Dial Plan
- Action URL
- Multicast
- Intercom
- Door Lock
- Access
- Alarm
- Camera

### LCD Language

Type:

### LCD Instruction config

First Line	<input type="text" value="Security center: Call"/>	Length Remain9	<input type="button" value="Modify"/>
Second Line	<input type="text" value="Call: RoomNo + Call"/>	Length Remain11	<input type="button" value="Modify"/>
Third Line	<input type="text" value="Unlock: * + PSW + *"/>	Length Remain12	<input type="button" value="Modify"/>
Fourth Line	<input type="text" value="Contact: up or down"/>	Length Remain11	<input type="button" value="Modify"/>

### Display

Backlight Level:

Backlight Time:

Screen Saver:

### Keypad Light

Active:

Key light time:  (1~60s)

### Switch

Switch Mode:

Switch-On Duration:  (1~600s)

Second Switch Mode:

Second Switch-On Duration:  (1~600s)

Second Door Open Method: