



A68(W) IP Phone User Manual

Version: 2.0

2017-08-26

Content

Contact ATCOM	5
1. Overview of A68(W)	6
1.1. Interface	7
1.2. Hardware	7
1.3. Software	8
1.4. Network	8
1.5. Management and Maintenance	9
1.6. Protocol	9
1.7. Compliant and Certified Standard	9
1.8. Packing list	10
1.9. Installation	10
2. Keypad and GUI	14
2.1. Keypad	14
2.2. Starting	16
2.3. Standby	18
3. Call Function	20
3.1. Answer the calls	20
3.2. Make Calls	21
3.3. Multiple line dial-up	23
3.4. Call Hold	23
3.5. Call Transfer	23
3.6. Mute calls	24
3.7. 9-Way Conference	24

3.8. Hang up the phone	26
3.9. Voicemail	27
4. Configuration	27
4.1. Status info	29
4.2. Call Features	31
4.2.1. Call Forward	32
4.2.2. Call Waiting	36
4.2.3. Auto Answer	37
4.2.4. DSS Keys	37
4.2.5. Key as Send	42
4.2.6. Hotline	43
4.2.7. Anonymous Call	44
4.3. Contacts	46
4.4. History	53
4.5. Message	56
4.6. Settings	58
4.7. Display	81
5. Advanced Feature	85
5.1. Codecs	85
5.2. Capture and Upgrading	85
5.3. Auto Provision	87
5.4. Export & Import configuration file	89
5.4.1. Export configuration file	89
5.4.2. Import configuration file	90
5.5. Export & Import CFG file	90

- 5.6. Export System log 91
- 5.7. Dial plan 91
 - 5.7.1. Replace Rule 92
 - 5.7.2. Dial-now 93
 - 5.7.3. Area Code 94
 - 5.7.4. Block Out 95
- 5.8. TR069 96
- 5.9. Action URL 98
- 5.10. Remote Control 98
- 6. WI-FI (For A68W/A68WAC) 99
 - 6.1. Configure the WIFI on the phone 99
 - 6.2. Configure the WIFI on the WEB 100
 - 6.3. Enterprise WiFi 101
- 7. FAQ 102
 - 7.1. How to reset to factory 102
 - 7.2. Upgrade the firmware on safe mode 103
 - 7.3. How to make IP call 103
- 8. Troubleshooting 105
 - 8.1. The phone is failed to register to SIP server 105
 - 8.2. The phone is failed to gain IP address 105
 - 8.3. Only one party can hear from another on calling 105
- 9. Abbreviation 106
- 10. FCC Caution 107

Contact ATCOM

Overview of ATCOM

ATCOM is the leading VoIP hardware manufacturer in global market. We have been keeping innovating with customer's needs oriented , working with partners to establish a total solution for SMB VoIP with IP phone , IP PBX and Asterisk cards.

With over 10 years' experience of R&D , manufacturing and service in network and VoIP filed;mission of creating the biggest value for IP terminals , we commit ourselves in supplying the competitive IP phone and other terminals for IP PBX , softswitch , IMS , NGN providers and carriers; supplying the competitive total VoIP solution for SMB market. We keep improving the customer's experience and creating the bigger value with our reliable products. Until now, our VoIP products have been available in 100+ countries and used by millions of end users.

Contact Sales

Address	Area C, A2F , Block 3 ,Huangguan Technology Park , #21 Tairan 9th Rd, Chegongmiao , Futian District , Shenzhen China
Tel	+ (86) 755-83018618-8806
FA41(w)	+ (86) 755-83018319
E-mail	sales@atcom.com.cn

Contact Technical Support

Tel	+ (86) 755-83018618-8003
E-mail	Support@atcom.com.cn

Website Address: <http://www.atcom.cn/>

Download Center: <http://www.atcom.cn/download.html>

1. Overview of A68(W)



A68(W)



A68(W)with AET

Type	POE	Power adapter	Wi-Fi	1000M
A68	Yes	Optional accessory	No	Yes
A68W	Yes	Optional accessory	Yes	Yes
A68WAC	Yes	Optional accessory	Yes 5G+2.4G	Yes

1.1. Interface

Power Input	DC 5V-2000mA or POE
LAN Port	RJ45
PC Port	RJ45
EXPAN port	RJ45
Headset Jack	RJ9
Handset Jack	RJ9

1.2. Hardware

LCD	480*272 4.3" TFT
FLASH	1Gbit
RAM	1Gbit
CPU	500MHz Dual-Core
LED Indicator	1 Status Light , 4 line indicators, 8 BLF indicators, 1 voicemail indicator, 1 headset indicator, 1 mute indicator
Expansion Module	RET: 44 programmable keys on each RET. AET: At most can connect 5 AET and configure 72 programmable keys on each AET.

1.3. Software

- Sip 2.0 (RFC3261) and other related SIP RFCs
- 32 SIP accounts registration
- STUN
- Jitter Buffer, VAD,CNG
- G711A, G711U, G722, G726-16, G726-24, G726-32, G726-40, G729, L16, iLBC_13_3, iLBC_15_2
- Echo Cancellation
- SIP Domain name, Authentication and Backup SIP Server
- DTMF (RFC2833, Inband, SIP INFO)
- Call transfer, Call forward, 9-ways conference, Call hold, Call back
- DND(Do Not Disturb), Auto answer, Blacklists, Block Call-ID, Block Anonymous call, Dial plan, IP call
- Phone book with 1000contacts and 200 blacklists
- Call History with 400 records include answered calls, missed calls, dialed calls and forward calls
- Auto update via HTTP, HTTPS, FTP, TFTP, DHCP, RPS and PNP
- Syslog
- SNTP,NTP
- Customized Ringtone
- Daylight Saving time
- VLAN, OpenVPN, Span to PC port, QoS
- 802.1X, LLDP
- Enterprise WIFI
- IPv4, IPv6, IPv4&IPv6
- WEB access with different login level
- Soft button: soft button *4
- Redundancy SIP server
- Multi-language: English, French, Hebrew, Russian, Spanish, Chinese, Persian, Polish, Portuguese, Turkish, German, Italian
- Support 2.4GHz WiFi and 5GHz WiFi

1.4. Network

- LAN/PC: Support Bridge mode
- Support VLAN
- Support Open VPN
- Support DHCP, STATIC IP
- Primary/Secondary DNS Server
- Support QoS
- Support LLDP
- Support 802.1X

- Support IPv4, IPv6, IPv4&IPv6
- Support Span pc port
- Support Enterprise WIFI
- Web access via HTTP&HTTPS
- A68WAC support 2.4GHz and 5GHz WiFi

1.5. Management and Maintenance

- Support firmware updating under safe mode
- Support different level user management
- Configuration via web , keyboard
- Support multi-language
- Firmware and configuration file auto provision
- Support system log

1.6. Protocol

- IEEE 802.3 /802.3 u 10 Base T / 100Base TX
- DHCP: Dynamic Host Configuration Protocol
- SIP RFC3261, RFC3262, RFC3263, RFC3264, RFC3265, RFC2543, RFC3489, RFC3842, RFC3515, RFC2976, RFC3428, RFC2327, RFC2782, RFC1889
- TCP/IP: Transfer Control Protocol/Internet Protocol
- RTP: Real-time Transport Protocol
- RTCP:RTP Control Protocol
- DNS: Domain Name Server
- TFTP: Trivial File Transfer Protocol
- HTTP:Hypertext Transfer Protocol
- FTP:File Transfer Protocol

1.7. Compliant and Certified Standard

- CE: AGC01180140201E2, AGC01180140202E2
- Comply with ROHS in EU
- Comply with ROHS in China



- Operation temperature: lower than 60° C
- Storage temperature: lower than 60° C
- Humidity: 10 to 90% no dew

1.8. Packing list

Model	A68(W)
Telephone	1 Unit
Handset	1 Unit
Handset cable	1 Unit
Stand bracket	1 Unit
Wall bracket	1 Unit
Power adapter	Standard
Network Cable	1 Unit, 1.5 meters
Quickstart Guide	1 Unit
Headset	Optional

1.9. Installation

Connect network cable

A68(W) is able to be connected with network via LAN port. Under the Bridge mode, other devices (Laptop, IP phone) is able to access network via the PC port of A68(W).

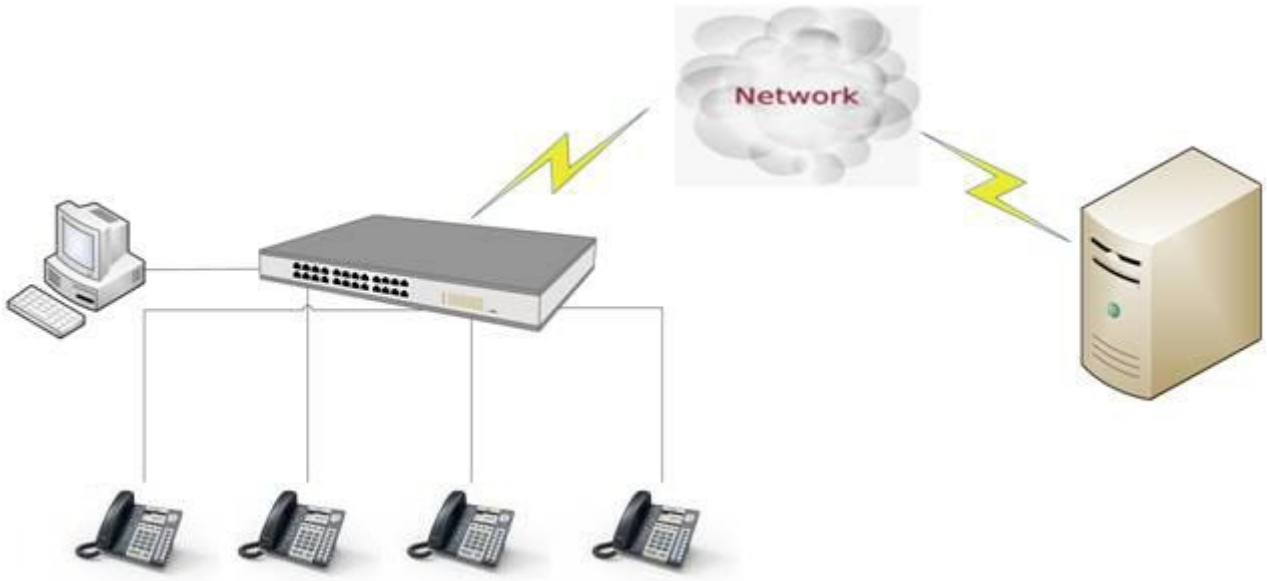

Connect WiFi

A41W is able to connect the WiFi.



1. Stand bracket installation instruction

A. Put the bottom side of the IP phone upside and press one-side joints of stand bracket into the slot, please refer the picture as below:

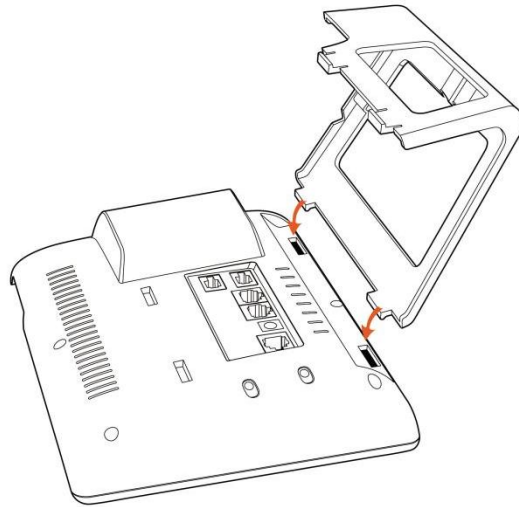

B. Press the other side joints into the slot according to the direction of the arrow:

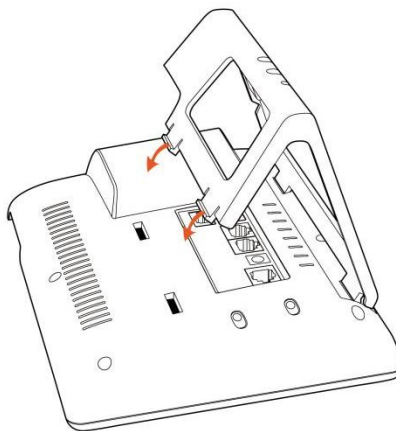

C. It is the right picture after fixing the stand bracket below:

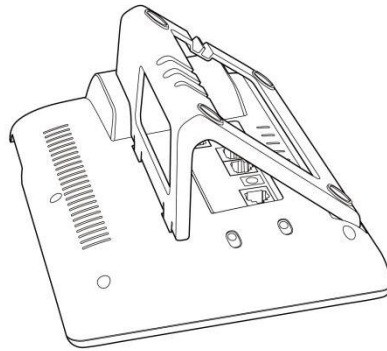

D. Disassemble the stand bracket:

Push the spring joint of stand and pull the stand according to the direction of the arrow. When the joints are pulled out of the slot, you can take off the stand bracket

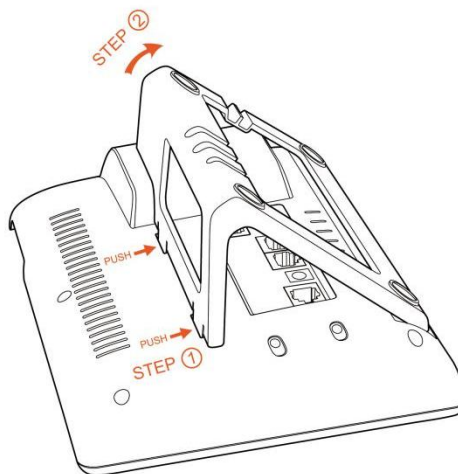

2. Wiring instruction

Plug in the power adapter, cable and handset or headset to the corresponding ports as below picture and press them to the slots on the stand bracket.

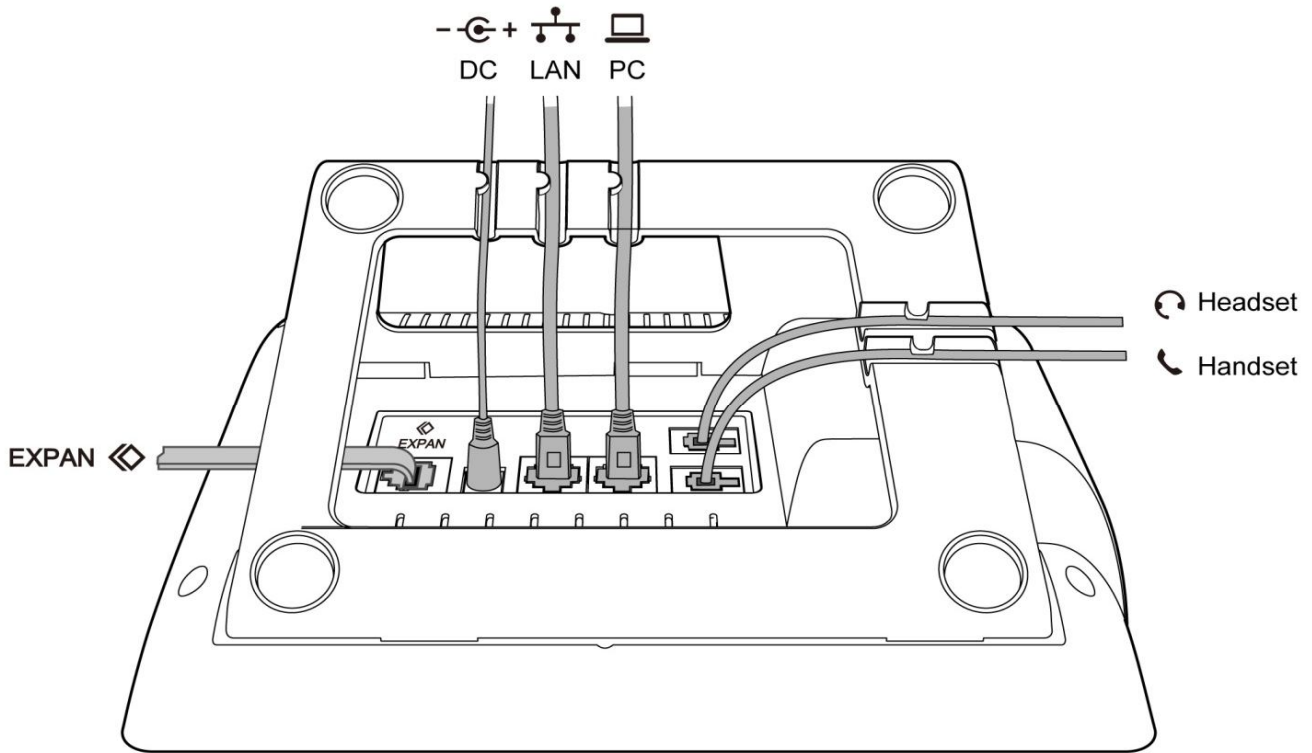





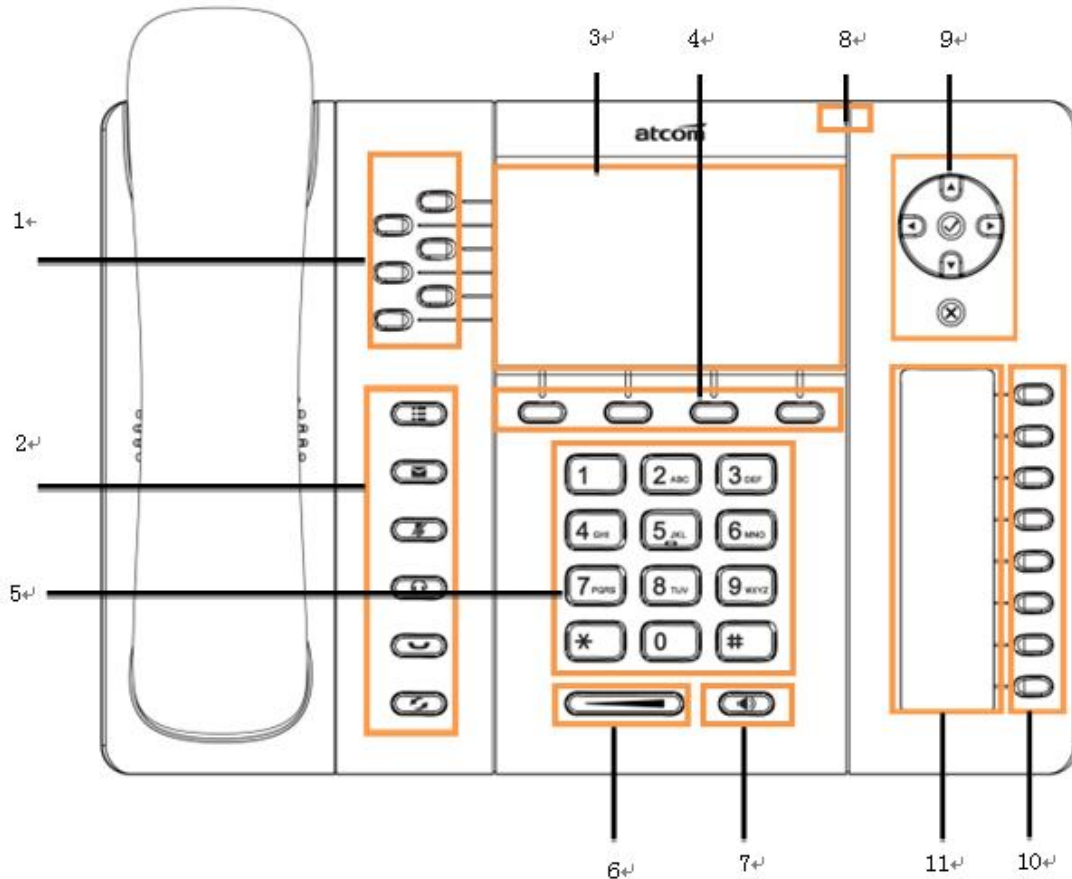







2. Keypad and GUI

2.1. Keypad



Soft Keys	<p>Press to select a function which displayed at the softkey zone of screen</p> <p>Display all optional functions at the last line of LCD screen.</p>
Status Indicator LED	<p>Indicates the phone's status,</p> <ul style="list-style-type: none"> ➤ If the phone is being started ,the LED is on ➤ If the phone is standby, the LED is off ➤ If there is income calling, the LED will blink at 120ms on, 120ms off. ➤ If there is a new message, the LED will blink at 600ms on, 600ms off.
LCD Screen	<p>All information such as date, time, phone number, incoming caller's ID(if available),line/call status, extension numbers and the soft key features are displayed on it.</p>
Dial pad	<p>Entering numbers or characters.</p>

<p>Navigation keys</p>	<p>Allows users to navigate(left, right, up, down).Press  can enter "Directory". Press  can enter "History".</p>
	<p>Adjust the volume(speaker/handset/headset/ring). Volume level will be displayed on LCD when pressing volume key.</p>
	<p>Confirm users' operation and show status when A68(W) is idle.</p>
	<p>Cancel users' operation.</p>
	<p>Enter menu settings.</p>
	<p>Pick up and hung up under the speaker mode.</p>
	<p>Mute the mic in a conversation by pressing the Mute button; this prevents the person on the active call from hearing what you or someone else in the room is saying.</p> <p>To un-mute, press the Mute button again.</p>
	<p>Pick up and hung up under headset mode.</p>
	<p>Check the Voicemail status.</p>
	<p>Hold the current call.</p>
	<p>Redial the last dialed number</p>
<p>Memory Key and Status Indicator</p>	<p>Aside the BLF LCD display, Programmable keys with built-in Red/Green dual-color LED lights to indicate different status:</p> <ul style="list-style-type: none"> ● Off——The account is unregistered ● Green on always——The account is idle. ● Red on always ——The account is being occupied. ● Red fast blinking——The account is ringing.
<p>BLF LCD Display</p>	<p>Display the content of each programmable key.</p>

2.2. Starting

1. When start on the phone, it turns to standby status in about 50 seconds.



2. After absolute boot up (first use or after reset to factory setting), User can select the Language and time manually, and choose to connect the WIFI or not in the WIFI phone.



















2.3. Standby



Area Item	Description
1	indicate the call status and show the default account
2	Time, Date
3	Softkey: "History", "Directory", "Forward,""DND"
4	Date

Icon on Standby UI

Icon	Description
	The account is registered successfully.
	The account is not registered successfully.
	The line is being occupied for dialing.



	New incoming call
	Call hold.
	Unavailable Network.
	Calling via handset
	Calling via Speaker.
	Calling via headset.
	WiFi Signal indicator
	Call Forward is activated.
	New Voicemail.
	Auto-Answer is activated.
	DND is activated

3. Call Function



3.1. Answer the calls

When there is an incoming call, phone will remind user with ringing. There are 3 ways to answer the call:



A. Answer by handset

Pick up the handset and talk with the caller. If you want to hang up, just put back the handset. When you are talking with the handset and want to switch to speaker or headset mode, please press  key or  key, and then put down the handset.

B. Answer by speaker

Press  key and talk with callers by built-in Micro-phone and Speaker. If you want to hang up, please press  key again. Switch calling or talking into handset mode by lifting the handset under speaker mode. Press  key will switch calling or talking into headset mode.

C. Answer by headset

Keep your microphone connected with the RJ9 headset jack, when there is an incoming call, press  and talk with the caller. If you want to hang up, please press  again. Pressing  can change calling or talking into speaker mode, and lifting the handset switches to handset mode.

3.2. Make Calls

A. Use the handset

Pickup the handset, the LCD will show the current lines (user is able to switch from line1 to line4 by pressing the line key beside the LCD). Press soft key "**Send**" to dial the number. When you hear the tones of "du~~du~~" and the phone number your dialed is being displayed on the LCD, the phone at the side of being called should be ringing. If the called party answers this calling, the call is established and the calling timer is started immediately.



B. Use the speaker

Press  key, the LCD will show the current lines (user is able to switch from line1 to line6 by pressing the line key beside the LCD). Input the phone number and press soft key "**Send**" to dial the number. When caller hear the tones of "du~~du~~" and the phone number your dialed is being displayed on the LCD, the phone at the side of being called should be ringing. If the called party answers this calling, the call is established and the calling timer is started immediately.



C. Use the headset

Press  Key, the LCD will show the current lines (user is able to switch from line1 to line6 by pressing the line key beside the LCD). Input the phone number and press soft key "**Send**" to dial the number. When caller hear the tones of "du~~du~~" and the phone number your dialed is being displayed on the LCD, the phone at the side of being called should be ringing. If the called party answers this calling, the call is established and the calling timer is started immediately.

D. Dial from phone book

1. Press  key to enter the menu and choose "**Directory**" option. Press "**Enter**" soft key and then find the contact person by navigation keys. When the certain contact person is highlighted, press "**Dial**" or just pick up the handset to call this number.
2. Pick up the handset, press "**Directory**" soft key, then find the contact person and press "**Dial**" soft key.
3. Pick up the handset, press  and enter "**Directory**", then find the contact person and press "**Dial**" soft key.

E. Dial from call history



1. Press  key to enter the menu and choose "**History**" option, then select one of call history entry, and press "**Dial**" soft key or pickup the handset to call this number.
2. Pickup the handset, press "**History**" soft key, then select one of call history entry, and press "**Dial**" soft key to call this number.
3. Pickup the handset, press  and enter "**Call list**", then select one of call history entry,

and press "**Dial**" soft key to call this number.

3.3. Multiple line dial-up

A68(W) supports up to 32 concurrent calls. If there is a new incoming call when you're talking on A68(W), the new incoming call will be displayed on LCD and status indicator LED will be fast blinking. User can press soft key "Hold" then press "Answer" to receive the new incoming call.

3.4. Call Hold

The current calling will be hold by pressing soft key "**Hold**" or , and the held call will be resumed after pressing soft key "**Resume**" or  or the corresponding line key. Even on 3-way conference calling, the conference will be held after pressing "**Hold**" key, and be resumed to 3-way conference after pressing "**Hold**" Key again. Remember the conversation is still on hold without being ended even if hung up under the status of hold.

3.5. Call Transfer

1. Attended call transfer

The attended transfer allows user to call a third-party before transferring the calling.

While calling, press the "**Transfer**" soft key to hold the current call and dial the target number you want to transfer to on the activated line and press "**Send**" soft key to call that number. After the target party answers the call, press "**Transfer**" soft key again to complete the transfer.

If the target number has been setup in the current BLF list, and you have already finished the necessary setup on Webpage of A68(W), there is an easier way to complete the attend transfer. While calling, press the corresponding BLF key of the target number and then press the "**Transfer**" soft key, the attend transfer will be achieved.

2. Blind call transfer

The blind transfer allows user to transfer a call without speaking to the third party. On the user side, the call will be ended as soon as the target phone number is dialed.

Operating steps: Press "**Transfer**" soft key to get more option, then press "**Blind**" soft key, input the transfer target number and press "**Send**" soft key.

If the target number has been setup in the current BLF list, and you have already finished the necessary setup on Webpage of A68(W), there is an easier way to complete the Blind transfer. While calling, press the corresponding BLF key of the target number, the blind transfer will be achieved.

3.6. Mute calls

The input audio will be not transmitted to peer phone after pressing  key, and the phone will be muted even switched among different modes of speaker, handset and headset.

To un-mute, just press  key again.

3.7. 9-Ways Conference

1. While on calling, press the soft key "**Conf**", input the 3_{rd} party's phone number and then press the softkey "**Dial**" or press the soft key "**Conf**" and press the corresponding BLF key to invite the 3_{rd} party to join a conference call.
2. After the third party answers the call, pressing "**Conf**" key again to establish the 3-way conference.



1. New call

- 1.1. While on the Conf call, the initiator can press the '**New call**' soft key to dial the call, then press the '**Conf**' soft key join the conf room;
- 1.2. Or when there is a new call incoming, answered the call, and press the 'Conf' soft key, the more can add 9-ways in the conf room.

2. Mute

- 2.1. While on the Conf call, the initiator can press the '**Mute**' soft key to forbidden the chosen conf member speak;
- 2.2. After '**Mute**', the initiator can press '**UnMute**' to recover the chosen ways speak.

3. More

- 3.1. While on the Conf call, the initiator can press '**More**' soft key to switch the first two keys feature.



4. Remove

4.1. While on the Conf call, the initiator can press the '**Remove**' soft key to remove the chosen conf member, the remove talking would be end the call.

4.2. If all the conf member be removed, the conf call would be ended.

5. Hold

5.1. While on the Conf call, the initiator can press the '**Hold**' soft key to hold the current conf call, and press the '**Resume**' would recover the call.

6. End

6.1. While on the Conf call, the initiator press the 'End' key can end the conf call.

3.8. Hang up the phone

1. Softkey hang up

While on calling, press the softkey "**End Call**" to hang up.

2. Handset hang up

Put back the handset at handset mode, the current calling will be hung up.

3. Speaker hang up

Press  key at speaker model, the current calling will be hung up.

4. Headset Hang up

Press  key at headset model, the current calling will be hung up.

5. Hang up one line call

Press the hook to hang up the current calling when 2 calls happened simultaneously.

3.9. Voicemail

A68(W) has a  key for entering voicemail box and indicating new voicemail. Press

 key to enter the menu to configure voicemail number if you have never configured it previously. Otherwise, the voicemail number will be called after pressing it.

4. Configuration

Press the key  to enter the Main Menu:

A68W and A68WAC:



Move the navigation key and press the softkey **“Enter”** or input the corresponding Number key
Select the item of Main Menu:

Number Key “1”	Enter “Status”
Number Key “2”	Enter “WiFi Setting”
Number Key “3”	Enter “Feature”
Number Key “4”	Enter “Directory”
Number Key “5”	Enter “History”
Number Key “6”	Enter “Message”
Number Key “7”	Enter “Settings”
Number Key “8”	Enter “Display”

A68:



Move the navigation key and press the softkey “**Enter**” or input the corresponding Number key
Select the item of Main Menu:

Number Key “ 1 ”	Enter “Status”
Number Key “ 2 ”	Enter “Feature”
Number Key “ 3 ”	Enter “Directory”
Number Key “ 4 ”	Enter “History”
Number Key “ 5 ”	Enter “Message”
Number Key “ 6 ”	Enter “Settings”
Number Key “ 7 ”	Enter “Display”

4.1. Status info



It’s able to check the status info via LCD Display or Web.

And the basic status and details status will be optional displayed on LCD display

1. Basic Status——IP address.MAC address. Firmware version。
2. Details Status——Network info. Production info and Account info in details.

Basic Status

You're able to check the basic status in both ways as below:

1. Press the key  on standby.
2. Press the key  and select the "Status" of Main Menu.
3. Move the navigation key, the status display the Model, IP, MAC, Firmware, More



Details Status

Select "**More**" and then press the softkey "**Enter**" to check details info, and move the navigation key to check more.

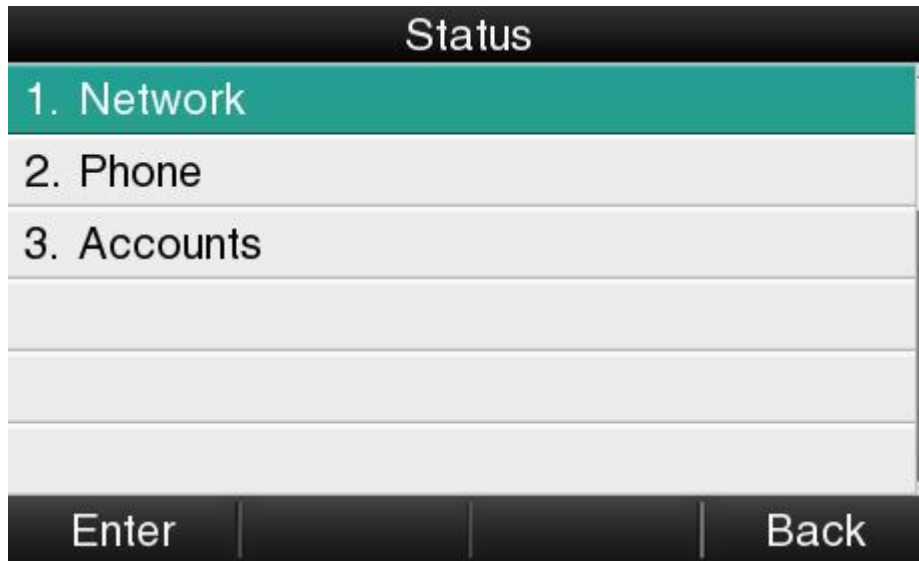

Press the softkey "**Enter**" to check status info, and "**Back**" to return the Basis Status page.

Check the Status info via Web

1. Check the IP address of IP phone;
2. Type the IP address on a web browser;
3. Input the username and password, the default user and password for Administrator is (admin, admin), for general user is (user, user), and then press "**Enter**".
4. By default, the Status info will be displayed.

4.2. Call Features

In this part, we will introduce the following content:

- [Call Forward](#)
- [Call Waiting](#)
- [Auto Answer](#)
- [DSS Keys](#)

- [Key as send](#)
- [Hotline](#)
- [Anonymous Calls](#)

4.2.1. Call Forward

“Call Forward” includes “Always Forward”, “Busy Forward”, “No Answer Forward”.



“Always Forward” has the highest priority, and “Busy Forward” has the same priority as “No Answer Forward”, that means once the function of “Always Forward” is activated, other call forward features will be unavailable.

Any type of Call forward feature is activated, the Icon  will be indicated on the LCD Display.

Always Forward

All incoming calls will be forwarded to target phone number once the “**Always Forward**” activated, setup this feature as follow and please move the navigation to check more:





Item	Operation	Description
Always	Press the key   or the soft key “ Switch ” to setup	Switch on or Switch off the feature. “ Enable ” mean this feature is enabled, “ Disable ” mean this feature

		is disabled.
Forward to	The Number key, "*"key, and "#"are permitted to be input.	Setup the target phone number which all incoming calls transferred to
On Code	The Number key, "*" key, and "#"are permitted to be input.	The feature code to enable all incoming calls forward, the phone will send the feature code directly to open all incoming calls forward
Off Code	The Number key, "*" key, and "#"are permitted to be input.	The feature code to disable all incoming calls forward, the phone will send the feature code to close all incoming calls forward directly

Busy Forward

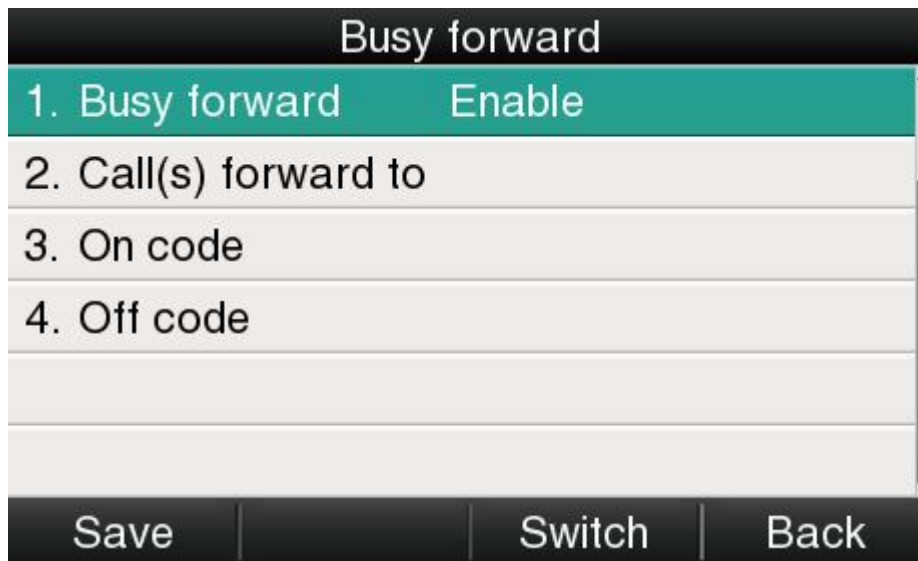
It means the phone is busy once the phone is not at standby mode. Setup this feature as below:







Item	Operation	Description
Busy	Press the key   or softkey "Switch" to setup	Switch on or Switch off the feature. "Enable" mean this feature is enabled, "Disable" mean this feature is disabled.
Forward to	The Number key, "*" key, and "#" are permitted to be input.	Setup the target phone number which all incoming calls transferred to

On Code	The Number key, “*” key, and “#” are permitted to be input.	The feature code to enable busy calls forward, the phone will send the feature code directly to open busy call forward
Off Code	The Number key, “*” key, and “#” are permitted to be input.	The feature code to disable busy calls forward, the phone will send the feature code directly to close busy call forward

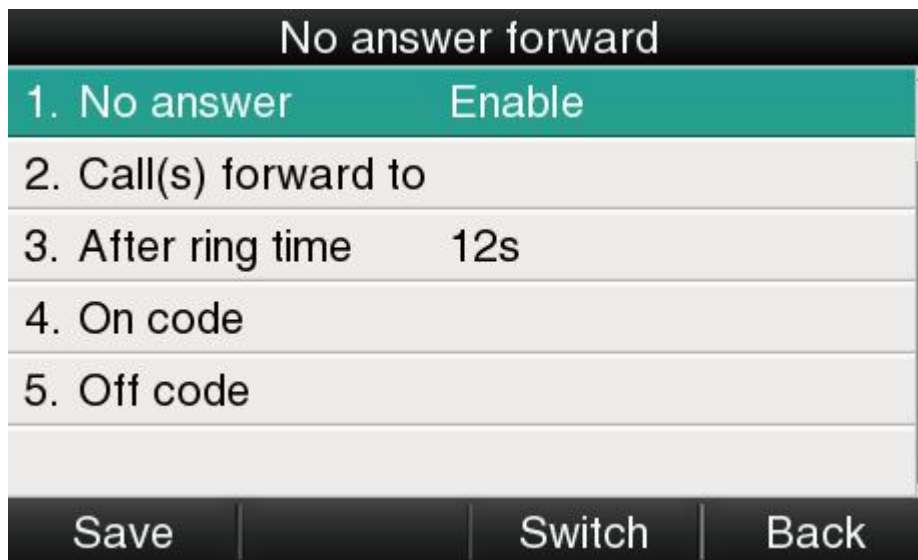
No Answer Forward

All incoming calls will be forwarded after time out, once the feature of “No Answer Forward” is activated. Setup this feature as below, and please move the navigation key to check more:



Item	Operation	Description
No Answer	Press the key   or softkey “ Switch ” to setup	Switch on or Switch off the feature. “ On ” mean this feature is activated, “ Off ” mean this feature is unactivated .
Forward to	The Number key, “*” key, and “#” are permitted to be input.	Setup the target phone number which all incoming calls transferred to
After Ring Time	Press the key   or softkey “ Switch ” to setup	Setup timer for no answer status. All incoming calls will be forwarded after time out once Call forward when no answer activated.

On Code	The Number key, “*” key, and “#” are permitted to be input.	The feature code to enable no answer call forward, the phone will send the feature code directly to open all incoming calls forward
Off Code	The Number key, “*” key, and “#” are permitted to be input.	The feature code to disable all incoming calls forward, the phone will send the feature code directly to close all incoming calls forward

Setup Call Forward Via Web

Set Call Forward via web: **Phone**→**Forward&DND**→**Call Forward**.





The screenshot displays the ATCOM web interface for configuring Call Forward. The navigation menu on the left includes: Forward&DND, Preferences, Features, Upgrade, Auto Provision, Configuration, Remote Control, Action URL, Tones, Dial Plan, Voice, Phone Lock, TR069, and Security. The 'Forward&DND' section is expanded, showing the following settings:

- Emergency:** Enabled (dropdown)
- Authorized Numbers:** (text input)
- Mode:** Phone (radio), Custom (radio)
- Account:** (dropdown)
- Always:** Off (dropdown)
 - Target: (text input) ⓘ
 - On Code: (text input) ⓘ
 - Off Code: (text input) ⓘ
- When Busy:** Off (dropdown)
 - Target: (text input) ⓘ
 - On Code: (text input) ⓘ
 - Off Code: (text input) ⓘ
- When No Answer:** Off (dropdown)
 - After Ring Time (s): 12 (dropdown) ⓘ
 - Target: (text input) ⓘ
 - On Code: (text input) ⓘ
 - Off Code: (text input) ⓘ

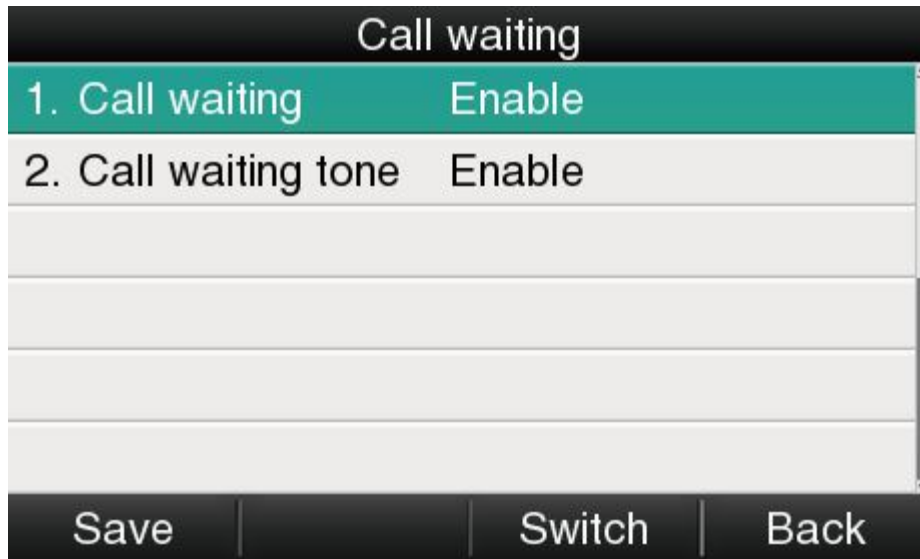
4.2.2. Call Waiting

The feature of "Call Waiting" is available by default. If switch off this feature, whatever multiple SIP accounts had been registered successfully, only one single active calling is permitted (for example Dialing, Ringing, Calling, Holding).



Item	Operation	Description
Call Waiting	Press the key   or softkey " Switch " to setup	Switch on or Switch off the feature. " Enable " mean this feature is enabled, " Disable " mean this feature is disabled.
Call Waiting Tone	Press the key   or softkey " Switch " to setup	Switch on or Switch off the prompt playing. " Enable " mean this feature is enabled, " Disable " mean this feature is disabled .

Setup call waiting via web: "Phone" → "Feature" → "General information" → "Call Waiting".

Setup call waiting Tone via web: "Phone" → "Feature" → "Audio Settings" → "Call Waiting Tone".

4.2.3. Auto Answer

The feature of "Auto Answer" is switched off by default. All incoming calls will be answered automatically when the phone is standby once "Auto Answer" is activated. "Auto Answer" when the phone is under "on Calling" status.

Please move the navigation key to check more:

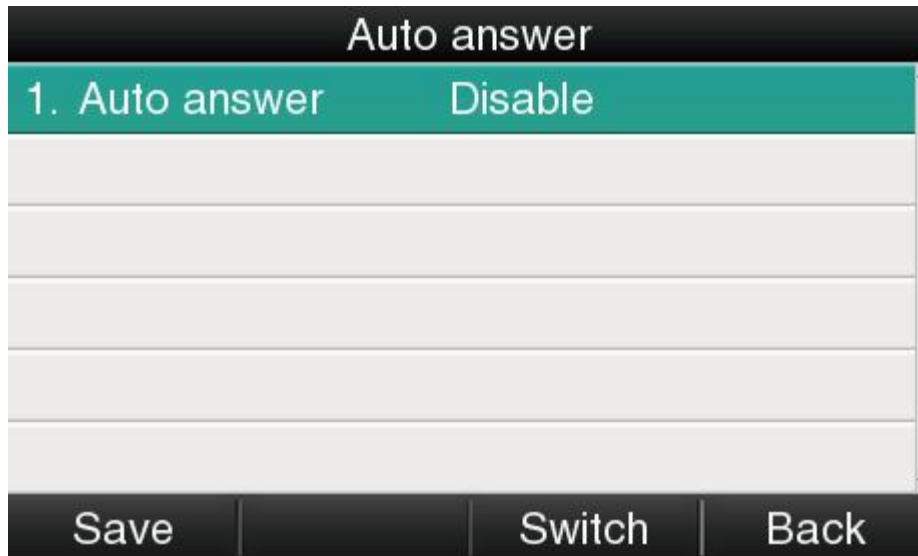

The Icon  will be indicated once "Auto Answer" is available.

Setup "Auto Answer" via Web: **"Phone" → "Feature" → "General information" → "Auto Answer"**

4.2.4. DSS Keys

The programmable keys include Line keys, Memory keys (aside the BLF LCD Display), Programmable keys and Soft keys on Standby UI.

Press the memory key for 2 seconds, it is able to modify the feature of each programmable key.

All programmable keys has been classified as "N/A", "Line Key", "BLF", "Key event", "Speed dial", "Intercom"

And the "Key Event" has been classified as "Conference", "Hold" "DND", "Redial", "Call return", "Pickup", "Call Park", "DTMF", "Directory".

Comments:



N/A

N/A means this key is not permitted to be set as a programmable key.

Line key

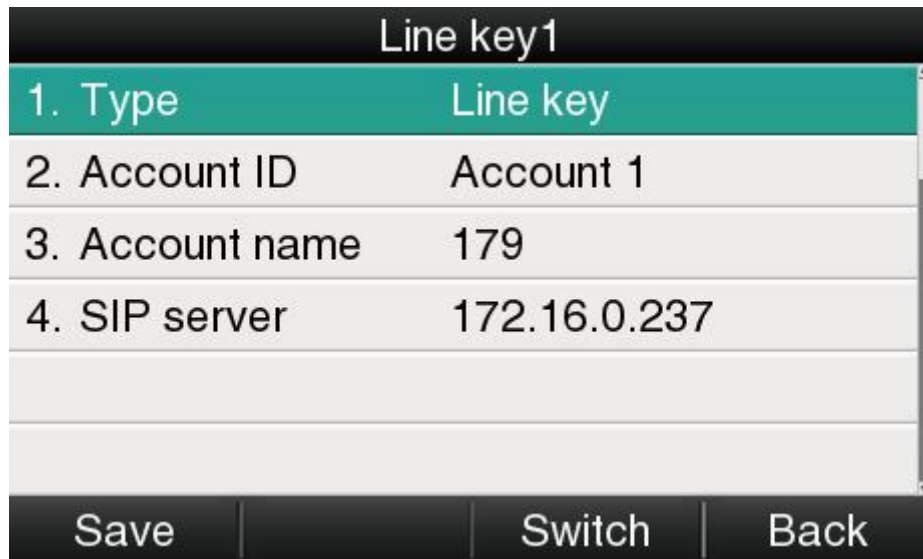
Display the account information, press it for making a call, answering incoming calls, call hold and resume.





Item	Description
Account ID	To display the account ID, press the soft key " Switch " or   to modify, the optional value is Account 1 to 4.
Account name	Display the account name of each account ID, non-modifiable.
SIP Server	The SIP server of each Account ID, non-modifiable. If not set any value for some account ID, the account name will be null.

BLF

Indicate the status of monitored account. Once set the BLF key with Pickup feature, user is able to answer the incoming call to the monitored account by pressing the corresponding BLF key. If the monitored account is idle, press the corresponding BLF key for speed dial.



Item	Description
Account ID	To display the account ID, press the soft key " Switch " or  、  to modify, the optional value is Account 1 to 4.
Label	To identify this key on LED, for example "blf"
Value	The phone number will be monitored by this key. For example, if user want to monitor the phone number (5003), please set "6070" here.
Extension	This code must be configured for pickup, and this code provide by Server. If the code is not matched by Server, the feature of pickup will not work.

Conference

The 3-way conference will be setup by pressing the key "Conf" while on calling. For more info, please refer to [Chapter 3.8](#).

The configuration item **Label** is a name to identify the key on LED, can be set as "conference".

Hold

The same feature as the key . For more info, please refer to [Chapter 3.5](#).

The configuration item **Label** is a name to identify the key on LED, can be set as "hold".

DND

Press this key will switch on or switch off the feature of "DND".

The configuration item **Label** is a name to identify the key on LED, can be set as "DND".

Redial

The same feature as the key .

The configuration item **Label** is a name to identify the key on LED, can be set as "redial".

Call return

Automatically dial the latest phone number in history.

The configuration item **Label** is a name to identify the key on LED, can be set as "return".

Call Pickup

Press this key to pick up if new incoming call to the monitored phone number.

Item	Description
Value	The phone number monitored for pickup
Label	A41 cannot definition label

Reminding: This code must be set for pickup, and this code can be set via Web only.

Set the Pickup code as follow:

Set the pickup code for one single Account: **Account**→**Advanced**→**Select an account to be configured**→**Directed Call Pickup Code**.

Set the pickup code for all Accounts: **Phone**→**Features**→**Call Pickup**→**Direct Call Pickup**. **Direct Call Pickup Code** (**Direct Call Pickup** should be set as **Enable**) .

Call Park

Press this key while on calling, the phone will dial the specified phone number, user will receive a code on the phone prompt, and then press the soft key "Transfer", the current calling will be parked successfully. At this moment, user is able to continue the parked calling with any other phones which registered on the same SIP server by dialing the code which user have received.

Item	Description
Value	The code for pickup the parked call and it is provided by SIP server.
Label	A41 cannot definition label

DTMF

Press this key while on calling, the phone will send the configured "**Value**" automatically.

Item	Description
Value	The value sent to remote end while on calling.
Label	A41 cannot definition label

Directory

Press this key to access Directory.

Speed Dial

Press this key while standby state, the specified target phone number will be dial from the specified account.

Item	Description
Value	The target phone number for speed dial
Label	A41 cannot definition label

Intercom

Press this key when the phone is idle, the phone will dial the specified "Value", and there mote end will answer the call automatically.

Note: This feature is supported by specified servers only.

Item	Description
Value	The target phone number for Intercom
Label	A41 cannot definition label

atcom
Basic Account Network **DSS Keys** Phone Contacts

Memory Keys

Line Keys

Programmable Keys

EXT Keys

Key	Type	Value	Label	Account	Extension
DSS Key1	BLF	113		Account 1	
DSS Key2	BLF	114		Account 1	
DSS Key3	Speed Dial	110		Account 1	
DSS Key4	BLF	111		Account 1	
DSS Key5	BLF	120		Account 1	
DSS Key6	BLF	123		Account 1	
DSS Key7	BLF	147		Account 1	
DSS Key8	BLF	112		Account 1	

4.2.5. Key as Send

The key "Key as Send" has the same function as the soft key "Dial".



Reminding: This key is not available while pre-dial. It's the only way to press the soft key "Dial" or pickup the handset to finish pre-dial.

The default value is "#", and it could be set as "*". If set the value as "disable", it means the function "Key as Send" is forbidden.

Set "Key as Send" via web : **Phone**→**Features**→**General Information**→**Key As Send**.

4.2.6. Hotline

Once "Hotline" has been set, the phone will automatically dial the hotline via the 1st available line if the phone stay in the standby status exceed the specified waiting time and there is no input (or input something and then all deleted).



Item	Description
Hotline	Set up the hotline number, the value is null by default.
Hotline timeout	Set up the timeout for hotline activation, 4 seconds by default.

Set hotline via web: **Phone**→**Features**→**General Information**→**Hotline**.

Set Hotline Time-out(secs) via web: **Phone**→**Features**→**General Information**→**Hotline Time-out(secs)**.







4.2.7. Anonymous Call

This function includes making anonymous calls and blocking all anonymous calls.

If switch on the feature "Anonymous call", all outgoing calls will be displayed as anonymous call in the other side.

If switch on the feature "Rejection", all incoming anonymous calls will be blocked automatically.



Item	Operation	Description
Accounts	press the soft key " Switch " or  .  to modify,	Select the Account for anonymous call.
Anonymous Call	press the soft key " Switch " or  .  to modify,	Switch on/off the feature of making anonymous calls.
Call On Code	The Number key, "*" key, and "#" are permitted to be input.	Set the feature code to turning on anonymous call, the phone enables anonymous call by sending the feature code to the server
Call Off Code	The Number key, "*" key, and "#" are permitted to be input.	Set the feature code to turning off anonymous call, the phone disables anonymous call by sending the feature code to the server
Rejection	press the soft key " Switch " or  .  to modify	Switch on/off the feature of blocking anonymous calls.
Reject On Code	The Number key, "*" key, and "#" are permitted to be input.	Set the feature code to turning on anonymous call rejection, the phone enables anonymous call rejection by sending the feature code to the server
Reject Off	The Number key, "*" key, and	Set the feature code to turning off anonymous call rejection, the

Code	"#" are permitted to be input.	phone disables anonymous call rejection by sending the feature code to the server
-------------	--------------------------------	---

Set Anonymous Call via web: **Account**→**Basic**→**Select the Account**→**Anonymous Call**.

Set Anonymous Call Rejection via web: **Account**→**Basic**→**Select the Account**→**Anonymous Call Rejection**.

4.3. Contacts

The content of Directory includes local phonebook and blacklist. Enter Directory as follow,

1. Press the soft key "Directory" when the phone is standby

2. Press the navigation key 

3. Press the menu key , and then select "Directory"

Configure the "Contacts" via Web:

All operations on Directory via Web will be not active until click "Save". When too much item existed in the Directory, it will be an easy way to search by keyword about name, Office Number, Mobile Number or other Number. The exactly matched item will be listed, otherwise you will be prompted "Not find the specified contact".

Local Contacts



Name and phone number are permitted to be saved into the local phonebook, and up to 400 items. It's able to add new group, new contact, edit or delete exist contact or dial, also move the item to blacklist.

Make calls from directory

Path to set on the phone:  → **Contacts** → **Local Contacts** → **All contact** → **Select the record** → **Dial**.



If only one phone number saved with the selected contact person, the phone number will be dialed while calling the contact person.

If multiple phone numbers saved with the selected contact person, user must select one of the phone numbers for dialing while calling the contact person.

Add new contact

Path to add new contact on the phone: **Press**  → **Contacts** → **Local Contacts** → **All contact** → **Add**.



Item	Operation	Description
Name	Input by number keys, "*" or "#" key, change the input-method via pressing the soft key "abc"	It's used to identify different phone numbers. Any reduplicated names are not permitted in the contacts.
Office	Input by number keys, "*" or "#" key, change the input-method via pressing the soft key "abc"	You can save three numbers at most. While calling a contact person in contacts, the phone will redirect to the page that to select one number to dial when multiple numbers are saved for one contact record
Mobile		
Other		
Ring	Press the key   or the soft key "Switch" to modify the account ID.	It's used to bundle each item with the corresponding ringtone, and the optional value is "Auto" or "Ringtone 1" to "Ringtone 10". "Auto" means the default ringtone will be played if new incoming call happened, otherwise the selected ringtone will be played.

Add new contact via web: **Contacts**→ **Contacts**→**Input messages**→**Add**→**Save**.

Edit the contact

User must re-edit the contact item while updating one item of local phonebook.

Path to edit the contact on the phone: Press  → **Contacts** → **Local Contacts** → **All contacts** → **Select the item to edit** → **Option** → **Edit** → **OK**.



Edit the contact item via Web: **Contacts** → **Contacts** → **click on the item to edit** → **modify messages** → **Click "Edit"** → **Click "Save"**.

Delete the contact

Path to delete the contact on the phone: Press  → **Contacts** → **Local Contacts** → **All contacts** → **Select the item to delete** → **Option** → **Delete** → **OK** → **OK**.

Press the soft key **"Cancel"** at the Warning UI to stop deleting.

Delete the contact item via web: **Contacts** → **Contacts** → **Select the item to delete** → **Click on "Delete"** → **Click on "Save"**.

Move to blacklist

Path to move to blacklist on the phone: Press  → **Contacts** → **Local Contacts** → **All contacts** → **Select the item to move** → **Option** → **Move to Blacklist** → **OK** → **OK**.

Press the soft key **"Cancel"** at the Warning UI to stop this operation.

Move the contact item to blacklist via web : **Contacts** → **Contacts** → **Select the item to move to blacklist** → **Click on "Move to black List"** → **Click on "Save"**.

Blacklist

The purpose of blacklist's feature is to block the phone number inside blacklist to call the host phone number, but it's available for the hosted phone number to call any phone number in the black list.

The most operation of blacklist is the same as local phonebook except for the feature "Move to Contacts", it means moving an item of blacklist to local phonebook to resume the phone number to dial the host phone number normally.

Remote phonebook

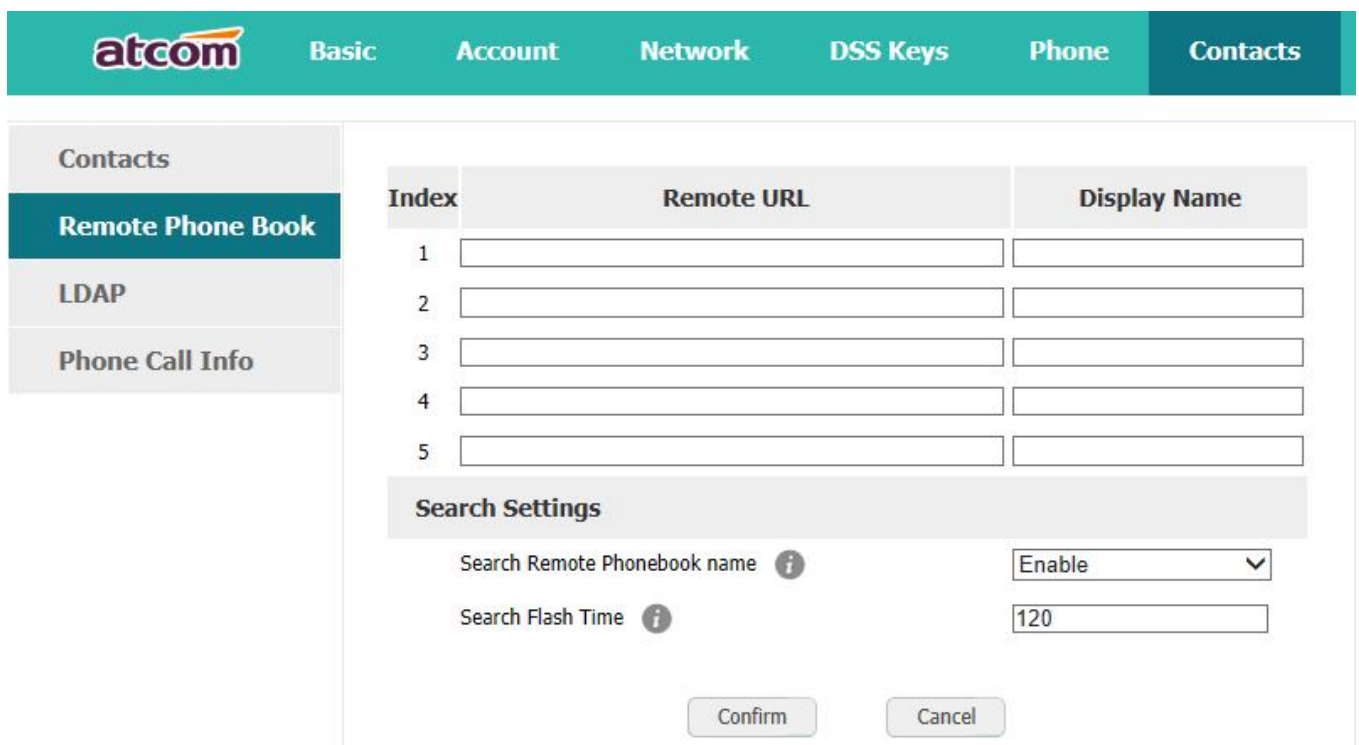

Index	Remote URL	Display Name
1	<input type="text"/>	<input type="text"/>
2	<input type="text"/>	<input type="text"/>
3	<input type="text"/>	<input type="text"/>
4	<input type="text"/>	<input type="text"/>
5	<input type="text"/>	<input type="text"/>



















Search Settings

Search Remote Phonebook name 

Search Flash Time 

1. Remote URL: Set a remote phonebook download path. Support the TFTP,FTP,HTTP and HTTPs server.
2. Display name: Set a display name on the phone.
3. Search Remote Phonebook name: Select "Yes" or "No" to enable or disable search remote phonebook name.
4. Search Flash Time: Set the search flash time. Defaults to 120.

LDAP

LDAP 	
Enable LDAP	<input type="text" value="Disable"/> 
LDAP Name Filter	<input type="text"/> 
LDAP Number Filter	<input type="text"/> 
Server Address	<input type="text"/> Port <input type="text" value="389"/> 
Base	<input type="text"/> 
Username	<input type="text"/> 
Password	<input type="text"/> 
Max Hits	<input type="text" value="50"/>  (1~32000)
LDAP Name Attributes	<input type="text"/> 
LDAP Number Attributes	<input type="text"/> 
LDAP Display Name	<input type="text"/> 
Protocol	<input type="text" value="Version 3"/> 
LDAP Sorting Results	<input type="text" value="Disable"/>  
LDAP Lookup For Incoming Call	<input type="text" value="Disable"/>  
LDAP Lookup For dialing	<input type="text" value="Disable"/>  



1. Enable LDAP: Select "Yes" or "No" to enable or disable LDAP.
2. LDAP Name Filter: Set the name of the LDAP search attributes.
3. LDAP Number Filter: Set the number of the LDAP search attributes.
4. Server Address: Set the LDAP server domain name or IP address.
5. Port: Set the LDAP server port number. Default to 389.
6. Base: Set the LDAP search base.
7. Username: Set the LDAP server username.
8. Password: Set the LDAP server password.
9. Max Hits(1~32000): Set the maximum number of search results from the LDAP server.
10. LDAP Name Attributes: Set the name of the attributes returned from the server.

11. LDAP Number Attributes: Set the number of the attributes returned from the server.
12. LDAP Display Name: The contact record the name of the displayed on the LCD.
13. Protocol: Set the phone to support LDAP protocol version. Defaults to version 3.
14. LDAP Sorting Results: Set the phone to sort the search results.
15. LDAP Lookup For Incoming Call: Set the phone for LDAP search when incoming call.
16. LDAP Lookup For dialing: Set the phone for LDAP search when dialing,

4.4. History

It includes the dialed, answered, missed and transferred items, mA41(w)imum 400 items.

User is able to review or delete any item of the history on the phone. And enter "History" in below ways:

1. Press the key 
2. Press the key , then select "History"
3. Press the soft key "History" while phone is under standby status

When any operations above is done, details info of all recent history will be listed on LCD display, include the type of each item, the name of contact person, date and time.

Also, user is able to check the detail info of call history via Web, but only review operation is allowed while accessing via web.

atcom						
Basic Account Network DSS Keys Phone Contacts						
Contacts						
Remote Phone Book						
LDAP						
Phone Call Info						
Dialed List		Missed List		Received List		Forwarded List
Index	Datetime	Duration	Local Identity	Name	Tel Number	
1	2017/5/5 10:03	00:00:02	115@172.16.0.237:5060	114	114@172.16.0.237	
2	2017/5/5 09:46	00:00:36	115@172.16.0.237:5060	120	120@172.16.0.237	

Make calls from history

Path to make calls from history on the phone: **Enter history UI→Select the item to dial→Dial.**

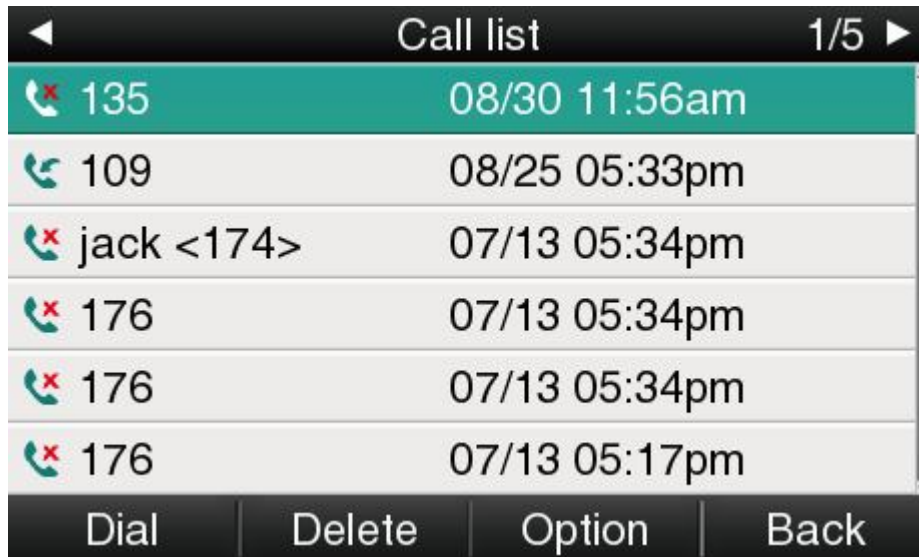

Delete one item from history

Path to delete one item from history on the phone: **Enter history UI→Select the item to delete→Delete.**

Check the details of history

Path to check the details of history on the phone: **Enter history UI→Select the item to check→Option→Detail→Press  or "OK".**

Local contacts		
1. Name	135	
2. Number	135	
3. Time	08/30 11:56am	
4. Duration	00:00:00	
Dial	Edit	Back

Add to Contact

1. Enter "Call History" → Select the target item → Option → add to Contact → Press the key  or soft key "Confirm".



At this moment an "edit" page will be popped up.

please move the navigation key to check more

Add to contact			
1. Name	135		
2. Office	135		
3. Mobile			
4. Other			
5. Account	Auto		
6. Ring	Auto		
Save	abc	Delete	Back

The item of "Office", "Mobile" and "Other" are able to be switched over between "Old Number" and current number. If the being operated item had been saved already in the contacts, "Old Number" will be the previous value, otherwise "Old Number" will be null. The UI page of "Add to Blacklist" is the same as above.

2. **Modify the contact name, phone number and ringtone.**

3. **Press the key  or soft key "Saved" to save the modification, press the key  or soft key "Cancel" to Cancel the modification.**

Add to Blacklist

For more info about this operation, please refer to [Add to Contact](#).

Delete all History's records

Path to delete all history's records on the phone: **Enter History UI**→**Option**→**Delete all**→

Press  or "OK".

4.5. Message

User will benefit from the feature of voicemail when they're not available to answer an incoming call or missed some incoming calls. However this feature must be supported by Server. Voicemail must be set up before using it.

Set the voicemail via Web: **Account**→**Basic**→**Select an account to configure**→**Voice Mail**.



Sometimes the voicemail push can't be reached in time, because the configuration problem with Server, you must configure some related parameter via Web to make the phone automatically send its request to Server for getting voicemail info.

Set "Subscribe for MWI" via web: **Account**→**Advanced**→**Subscribe for MWI**.

Set "MWI Subscription Period(secs)" via web: **Account**→**Advanced**→**MWI Subscription Period(secs)**.

Set Voice Mail



There are 3 different methods to set up the voicemail,

1. Press the key  after factory set
2. Press the key  for a while
3. Press the key  → Select "Message" → Setup Voicemail



View Voice Mail

User is able to check voicemail in below ways:

1. Setup voicemail number → Press the key 
2. Press the key  → Select "Message" → "View Voicemail"

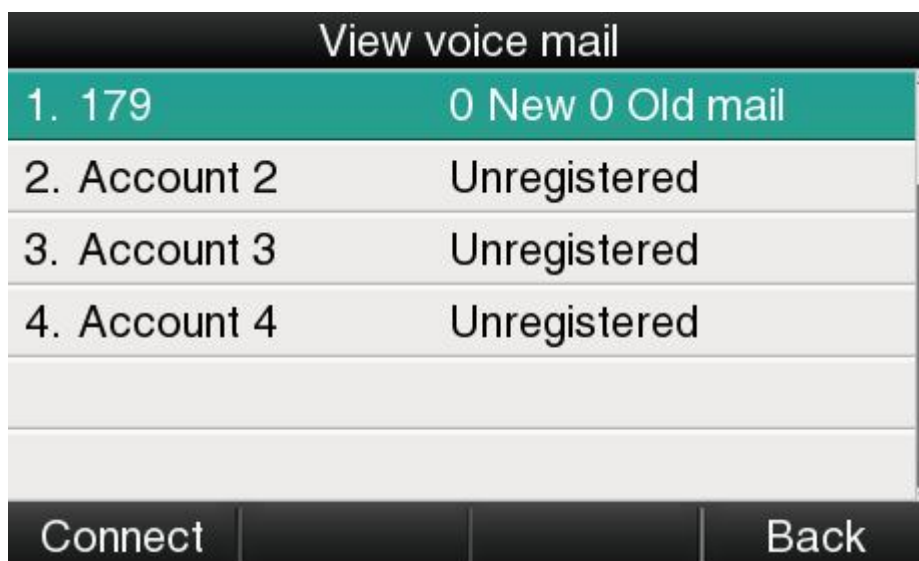

Select the account with "N new N old mail", and press the soft key "Connect", the corresponding voicemail will be connected.

Select the account with "Unregistered", and press the soft key "Connect", the setting page of Voicemail will be popped up.

4.6. Settings

Basic settings and Advanced settings will be introduces in this part,

Basic Settings

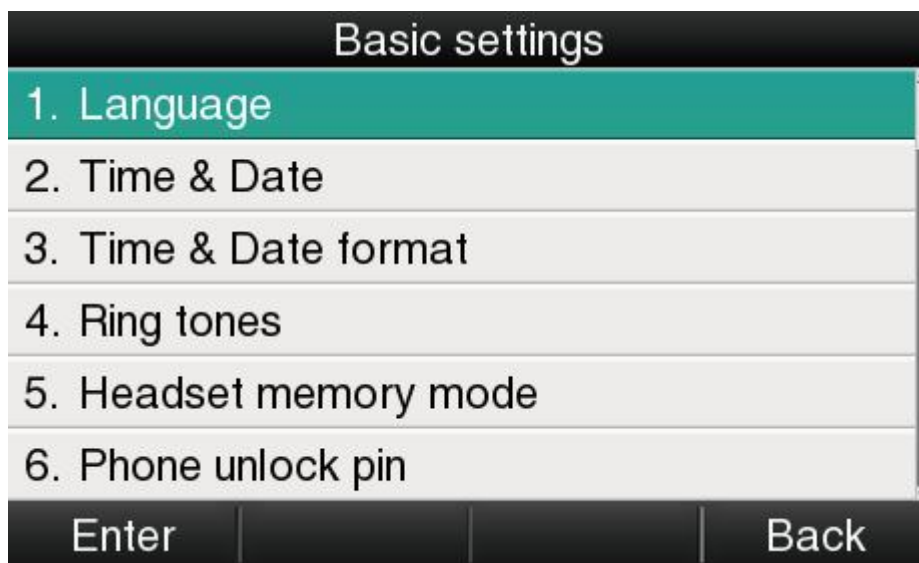

1. Language

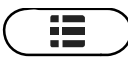
A68(W) supports multiple language, to modify the language, please press the key  → **Setting** → **Basic setting** → **Language** → **Select the target language and press the soft key "Save"**.



Set language via web: There is a drop-down box at the top left corner of webpage, choice one kind of language and click, the language will take effect immediately.

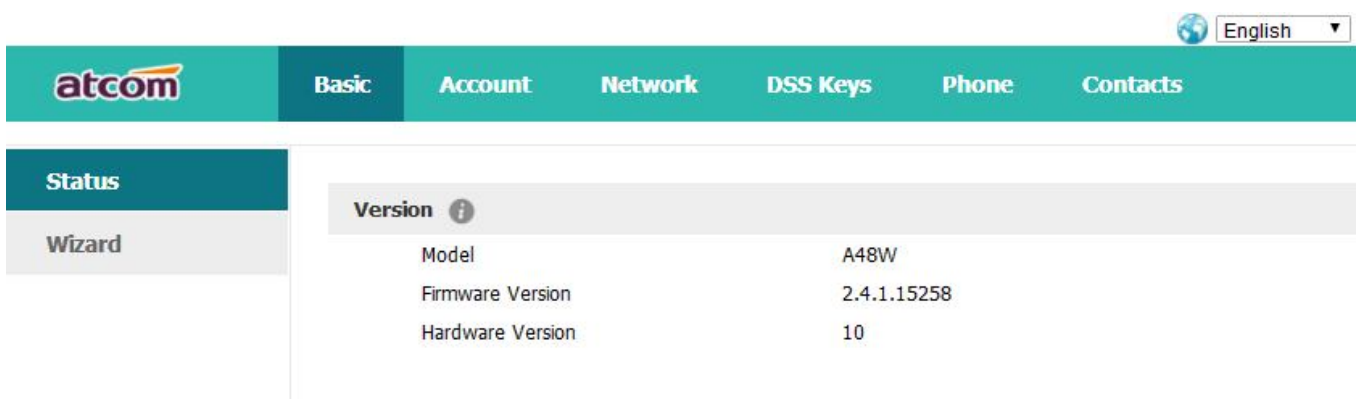

2. Time & Date





Time & Date will be displayed at the standby page of A68(W), and these info will be related with all process of IP phone. "Time & Date" can be gained by NTP Server automatically or set manually.

NTP Setting

Path to set on the phone: Press  → **Settings** → **Basic Settings** → **Time & Date** → **NTP Settings**.

Please move the navigation key to check more:



Item	Operation	Description
Time Zone	Press the key   or soft key "Switch" to modify it.	Select the correct Time Zone for the IP phone.
NTP Server	Key in the IP address of domain name by the number keys, "*", "#"	Specify the NTP Server
Secondary NTP Server	Key in the IP address of domain name by the number keys, "*", "#"	Specify the standby NTP Server
Daylight-Saving Time	Press the key   or soft key "Switch" to modify it.	Optional: "Off", "Auto" or "Manual". And "Manual" mean user must set this via web.

Set NTP via Web: **Phone**→**Preference**.

Time Zone	<input type="text" value="+8 China(Beijing)"/>	
Primary NTP Server	<input type="text" value="pool.ntp.org"/>	
Secondary NTP Server	<input type="text" value="time.windows.com"/>	
Update Interval(secs)	<input type="text" value="1000"/>	
daylight	<input type="text" value="Disable"/>	
Fixed Type	<input checked="" type="radio"/> By Date <input type="radio"/> By Week	
Start Month	<input type="text" value="January"/>	
Start Date	<input type="text" value="1"/>	
Start Hour of Day	<input type="text" value="0"/>	
Start Day of Week	<input type="text" value="Sunday"/>	
Start Week of Month	<input type="text" value="First In Month"/>	
Stop Month	<input type="text" value="January"/>	
Stop Date	<input type="text" value="1"/>	
Stop Hour of Day	<input type="text" value="0"/>	
Stop Day of Week	<input type="text" value="Sunday"/>	
Stop Week of Month	<input type="text" value="First In Month"/>	
Offset(minutes)	<input type="text" value="0"/>	

Item	Operation	Description
Time Zone	Click drop-down box to select	Set a time zone matches condition
Primary NTP Server	Manual input	The primary NTP server that provide time and date
Secondary NTP Server	Manual input	The secondary NTP server that provide time and date
Update Interval(secs)	Manual input	The interval that the phone gains time and date from NTP server
Daylight	Click drop-down box to select	A switch to control the status that whether to enable the daylight or not
Fixed Type	Radio content	Daylight fixed type, only the specified items are configurable

Start Month	Click drop-down box to select	The month that the daylight rule begins taking effect
Start Date	Manual input	The day that the daylight rule begins taking effect
Start Hour of Day	Manual input	The hour of day that the daylight rule begins taking effect
Start Day of Week	Click drop-down box to select	The day of week that the daylight rule begins taking effect
Start Week of Month	Click drop-down box to select	The week of month that the daylight rule begins taking effect
Stop Month	Click drop-down box to select	The month that the daylight rule stops taking effect
Stop Date	Manual input	The day that the daylight rule stops taking effect
Stop Hour of Day	Manual input	The hour of day that the daylight rule stops taking effect
Stop Day of Week	Click drop-down box to select	The day of week that the daylight rule stops taking effect
Stop Week of Month	Click drop-down box to select	The week of month that the daylight rule stops taking effect
Offset(minutes)	Manual input	The offset time that daylight rule takes effect

Manual Settings

Path to set on the phone: Press  → **Settings** → **Basic Settings** → **Time & Date** → **Manual Settings**.

Please move the navigation key to check more:

Manual settings	
1. Year	2017
2. Month	08
3. Day	31
4. Hour	10
5. Minute	26
6. Second	40
Save	123 Delete Back

Item	Operation	Description
Year	Key in "Year" with the number key, "*"and "#"	Date info
Month	Key in "Month" with the number key, "*"and "#"	
Day	Key in "Day" with the number key, "*"and "#"	
Hour	Key in "Hour" with the number key, "*"and "#"	Time info
Minute	Key in "Minute" with the number key, "*"and "#"	
Second	Key in "Second" with the number key, "*"and "#"	

Set the Time & Date manually via web: **Phone→Preference.**

Manual Time	Enabled	
Date	2017-08-31	Current Date
Time	10:28:31	Current Time

Item	Operation	Description
Manual Time	Click the drop-down box to select	A switch to control the status whether to enable the manual time or not

Date	Manual input, click "Generated Date" to gains date from the computer	Set date manually
Time	Manual input, click "Generated Time" to gains time from the computer	Set time manually

3. Time&Date Format

Path to set on the phone: Press  → **Settings** → **Basic Settings** → **Time & Date Format**.

please move the navigation key to check more:

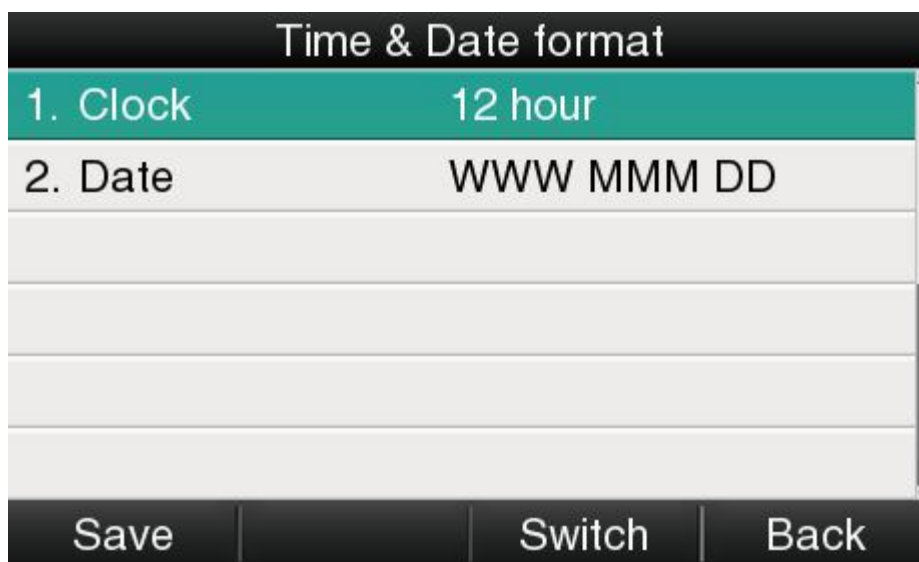

Item	Optional	Example of result
Clock	12 hour	03:30pm
	24 hour	15:30
Date	WWW MMM DD	TuesdayOct.16
	DD-MMM-YY	16-Oct.-16
	YYYY-MM-DD	2016-10-16
	DD/MM/YYYY	16/10/2016

	MM/DD/YY	10/16/16
	DD MMM YYYY	16,Oct.,2016
	WWW DD MMM	Tuesday,17,Oct.



Set the Time &Date Format via Web: **Phone**→**Preference**

4. Ringtones

10 different ringtones have been provided by A68(W) for selection. Path to set on the phone:

Press the key  → **Settings**→**Basic Settings**→**Ringtones**.



For the selected ringtone, there is a dot inside the circle. Press the key . to select other ringtone for playing.

Set ringtones via Web: **Account**→**Basic**→**Ring tones**.

Replace Ring tone

It supports upload custom ring, then auto replace last system ringtone.



5. Headset Memory Mode

Headset memory mode can be used to control the default device to make or answer calls. This function is disabled by default, which means the phone will communicate with others by hand-free when pre-dial or making calls from history or contacts, and so is the situation that pressing "Answer" soft key to accept an incoming call. Once this function is enabled, the phone

will make or answer calls by headset. Long press  can change the status of the "Headset Memory Mode".

This function can be configured on the phone only: Press  → **Settings** → **Basic Settings** → **Headset Memory Mode**.

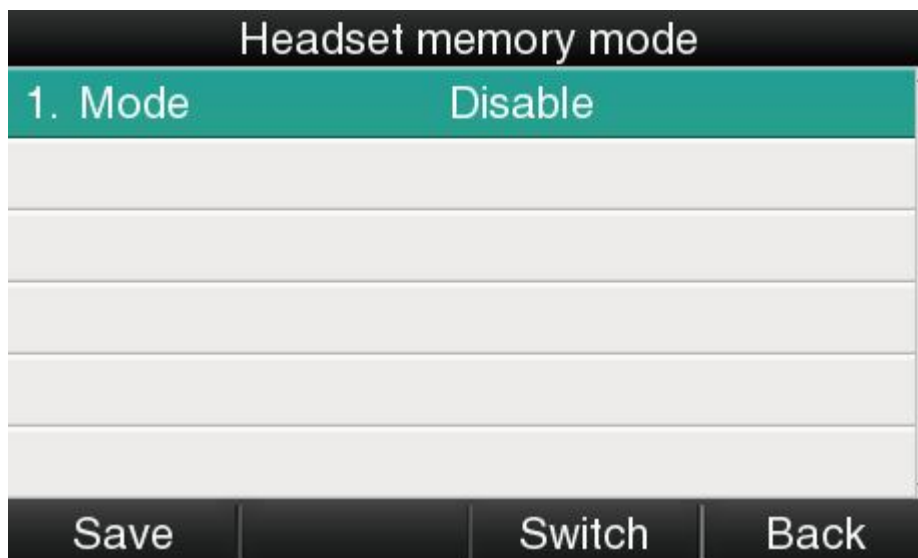

6. Phone Unlock PIN

Phone Unlock PIN: Unlock the phone locked conditions.

please move the navigation key to check more and press the cancel key to back the function,

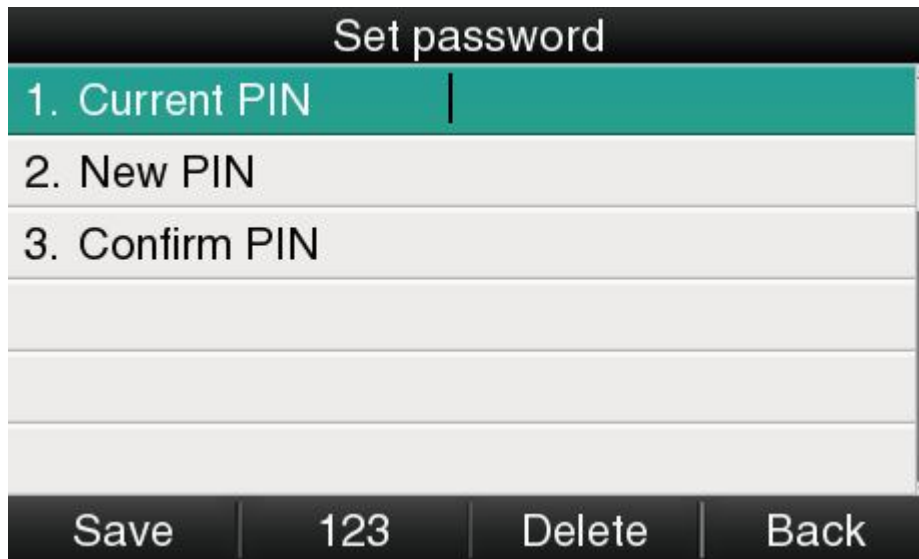

Item	Operation	Description
Current PIN	Manual input	Input the phone current PIN, Default factory pin:123
New PIN	Manual input	Set the new PIN
Confirm PIN	Manual input	Confirm the new PIN

Advanced Settings

Password will be requested while accessing the page of "Advanced Settings". This password is the same as the user's("admin") to access.

1. Account

path to set the account info on phone: Press  → **Settings** → **Advanced Settings** → **Input password** → **Accounts**.



Item	Description
Activation	The status of account, the default is "Enable", if set this as "Disable", the account will be forbidden.
Label	It will show on the phone, can skip this item
Display Name	Parameter that in the SIP, if the SIP Server is supportable, this name will show on the phone of called
Register Name	The register ID, supplied by SIP Server, can skip this item
User Name	Account ID
Password	Password for account
SIP Server	The address that accounts needed to register from
Outbound Status	The status of Outbound Server, "off" by default
Outbound Proxy	IP address of Outbound Agency
Stun Status	The status of Stun Server, "off" by default
Stun Server	IP address of Stun Server

Configure account via web: **Account**→**Basic**

atcom		Basic	Account	Network	DSS Key	Phone	Contacts
Basic	Account		Account 1				
Codecs	Register Status	Register failed					
Advanced	Account Active	Enable					
	Label	<input type="text"/>					i
	Display Name	<input type="text"/>					i
	Register Name	<input type="text"/>					i
	* User Name	<input type="text"/>					i
	Password	<input type="text"/>					i
	* SIP Server	<input type="text"/>	Port	5060	i		
	Enable Outbound Proxy Server	Disable					i
	Outbound Proxy Server	<input type="text"/>	Port	5060	i		
	Transport	UDP					i
	NAT Traversal	Disable					i
	STUN Server	<input type="text"/>	Port	3478	i		

2. Set Password

The password for Advanced Settings also is used for Web access as the role "admin". Path to

set password on phone: Press  → **Settings** → **Advanced Settings** → **Input password** → **Set Password**.

Set password

1. Current PWD	
2. New PWD	
3. Confirm PWD	
Save	abc
Delete	Back

Item	Description
Current PWD	The current password for web access as the role of "admin", it's "admin" by default.
New PWD	To set the new password, blank is acceptable.
Confirm PWD	Input the new password again, to confirm the new password.

Set password via Web: **Phone**→**Security**.

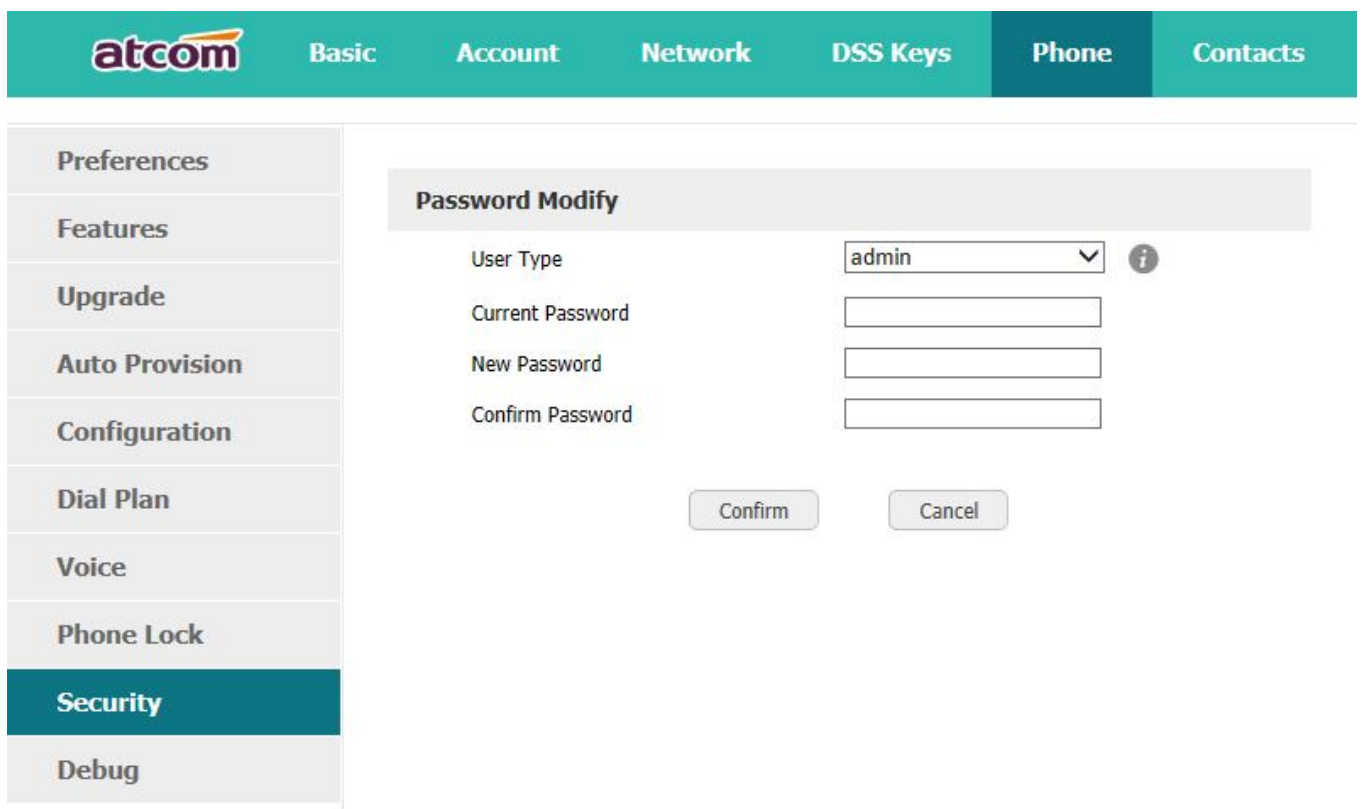

The screenshot shows the atcom web interface. The top navigation bar includes the atcom logo and tabs for Basic, Account, Network, DSS Keys, Phone, and Contacts. The Phone tab is selected. On the left, a sidebar menu lists various settings: Preferences, Features, Upgrade, Auto Provision, Configuration, Dial Plan, Voice, Phone Lock, Security (highlighted), and Debug. The main content area displays the "Password Modify" form. This form includes a "User Type" dropdown menu set to "admin", and three input fields for "Current Password", "New Password", and "Confirm Password". Below the input fields are "Confirm" and "Cancel" buttons.

3. Network

Path to set network parameters on phone: **Press**  → **Settings**→**Advanced Settings**→**Input the password**→**Network**.

please move the navigation key to check more:

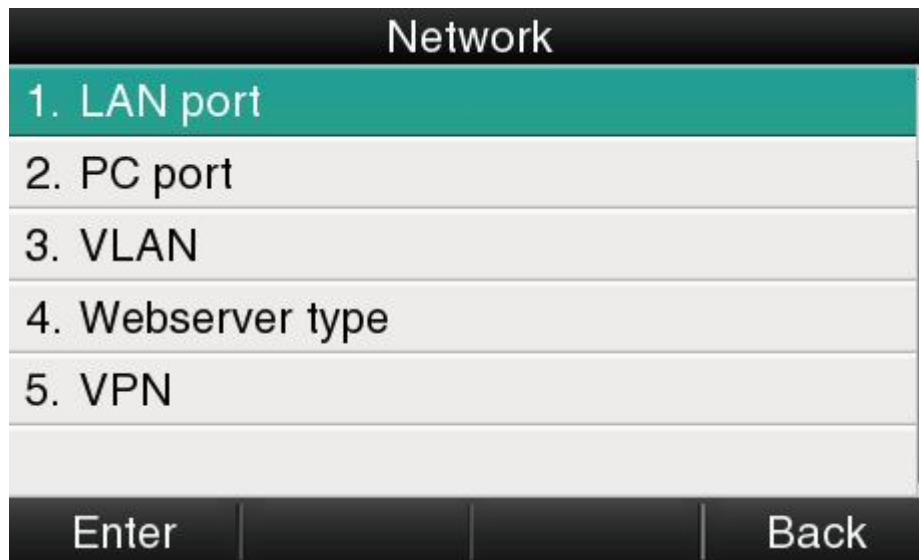

➤ **LAN Port**

Connect the phone with local network via LAN port, there are three modes to choose: IPV4, IPV6, IPV4&IPV6

Set the LAN port via Web: **Network**→ **Basic**.

atcom

[Basic](#)
[Account](#)
[Network](#)
[DSS Keys](#)
[Phone](#)
[Contacts](#)

Basic

Wi-Fi

Advanced

Internet Port
IPv4 & IPv6 ▼

IPv4 Config

DHCP i

Static IP Address i

* IP Address

* Subnet Mask

* Default Gateway

Static DNS
 Off On i

Primary DNS

Secondary DNS

IPv6 Config

DHCP i

Static IP Address i

* IP Address

* IPv6 Prefix(0~128)

* Default Gateway

Static DNS
 Off On i

Primary DNS

Secondary DNS

IPV4

The phone gains network via IPV4 by default;

And gains IP address via DHCP and Static IP two modes.

LAN port

1. Mode IPv4

2. IPv4

Save
Switch
Back

IPV6

The phone supports IPV6 network mode, it needs the IPV6 Switch support.

And gains IP address via DHCP and Static IP two modes.

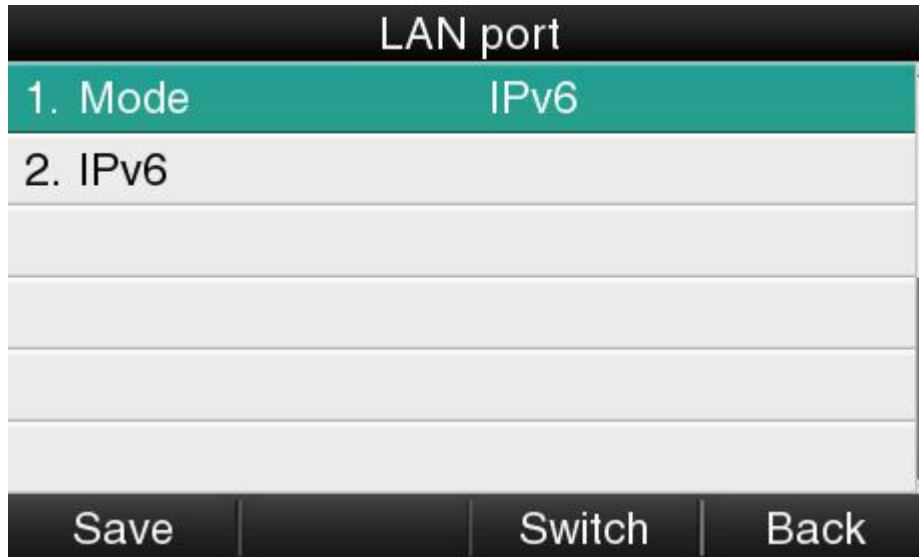

IPV4&IPV6

The phone also supports IPV4&IPV6 network mode.



➤ PC Port

Only bridge mode support by PC port.

➤ VLAN

The feature of VLAN must be supported by network switch, and by default this feature it's not activated.

VLAN	
1. LAN status	Disabled
2. LAN VID number	0
3. LAN priority	0
4. PC status	Disabled
5. PC VID number	0
6. PC priority	0

Save Switch Back

Set the VLAN via Web: **Network** → **Advanced** → **VLAN**.

➤ Webserver Type

Webserver type include HTTP and HTTPS, different access port will be required by different access type, user is able to confirm the port info at the webpage, HTTP & HTTPS are both permitted by default.

Set Webserver type via Web: **Network** → **Advanced** → **WebServer** → **Type**.

➤ VPN

A68(W) support the feature of Open VPN, and this feature must be supported by VPN Server.

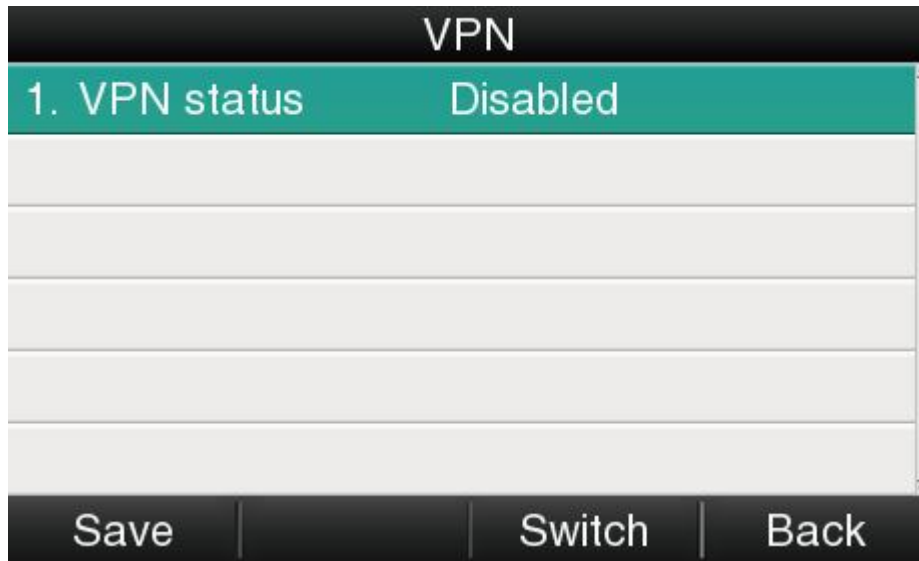

Set the VPN via Web: **Network** → **Advanced** → **VPN**.



VPN ⓘ	
Active	<input type="text" value="Disable"/>
Upload OpenVPN Config	<input type="text"/> <input type="button" value="Browse..."/>
	<input type="button" value="Import"/>

➤ **LLDP**

A68(W) supports LLDP, and enable in default. If the phone is connected to a switch and using LLDP, the switch would notifies IP phone of VLAN information.



Set the LLDP via Web: **Network** → **Advanced** → **LLDP**

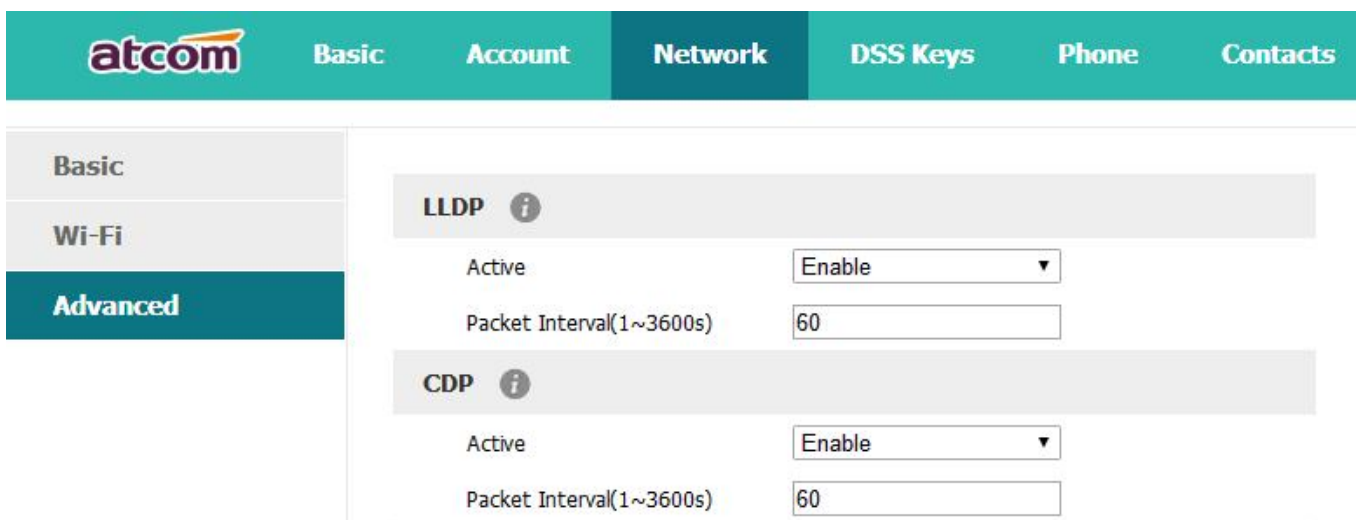

➤ 802.1X

IEEE 802.1X authentication is an IEEE standard for Port-based Network Access Control(PNAC), part of the IEEE 802.1 group of networking protocols. It offers an authentication mechanism for devices to connect to a LAN or WLAN.

It supports protocol EAP-MD5, EAP-TLS, EAP-PEAP/MSCHAPv2, EAP-TTLS/EAP-MSCHAPv2, EAP-PEAP/GTC and EAP-TTLS/EAP-GTC for 802.1X authentication.



Set the 802.1X via the webpage: **Network** → **Advanced** → **802.1X**

802.1X i

Mode	<input type="text" value="Disable"/>	▼
Anonymous Identity	<input type="text"/>	
Identity	<input type="text"/>	
Md5 Password	<input type="text"/>	
CA Certificates	<input type="text"/>	<input type="button" value="Browse..."/>
	<input type="button" value="Import"/>	
Device Certificates	<input type="text"/>	<input type="button" value="Browse..."/>
	<input type="button" value="Import"/>	

4. Keypad Lock

It support enable or disable the keypad lock feature, if enable, **the default password is 123:**

Please move the navigation key to check more

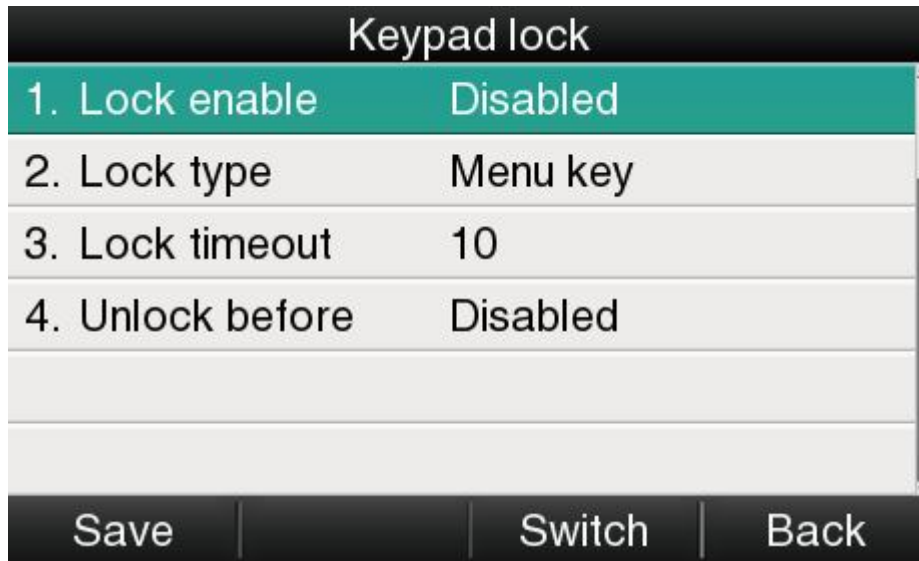

Keypad lock via webpage: **phone**→**Phone lock**

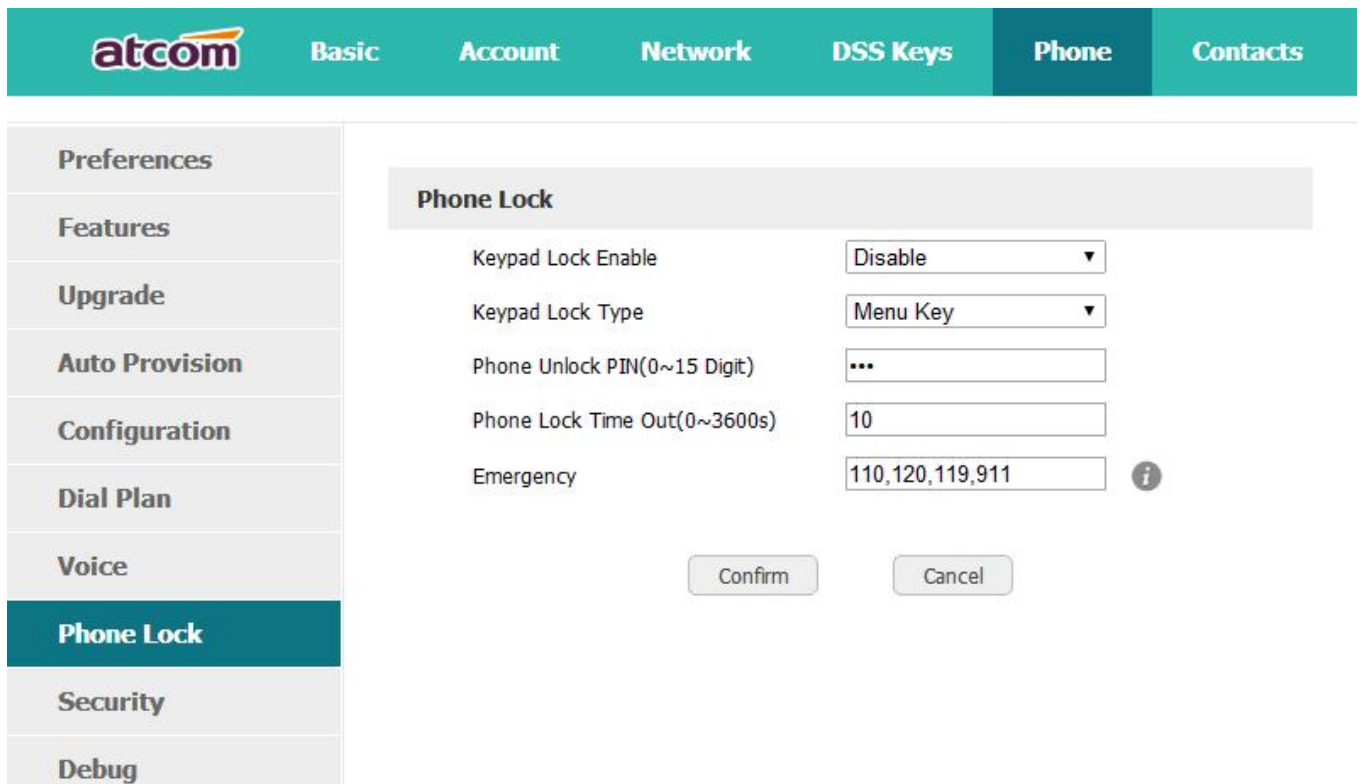

1. Keypad Lock Enable: select "Yes" or "No" to enable or disable keypad lock
2. Keypad Lock Type: Menu key/Function keys/All keys/Answer call only.
3. Phone Unlock PIN(0~15 Digit):set the phone unlock PIN. Range: 0~15 digit.
4. Phone Lock Time Out(0~3600s): set the phone lock time out. Range: 0~3600s
5. Emergency :set emergency number. Default to 110.120.119 and 911.

5. Reboot

After the restart, the phone will back to standby interface.

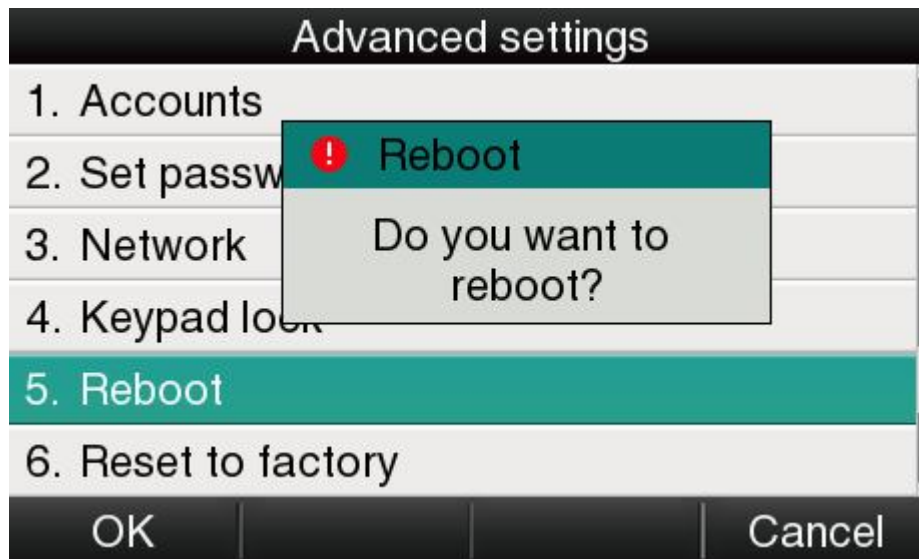

Reboot via webpage: **Phone**→**Upgrade**→**Reboot**

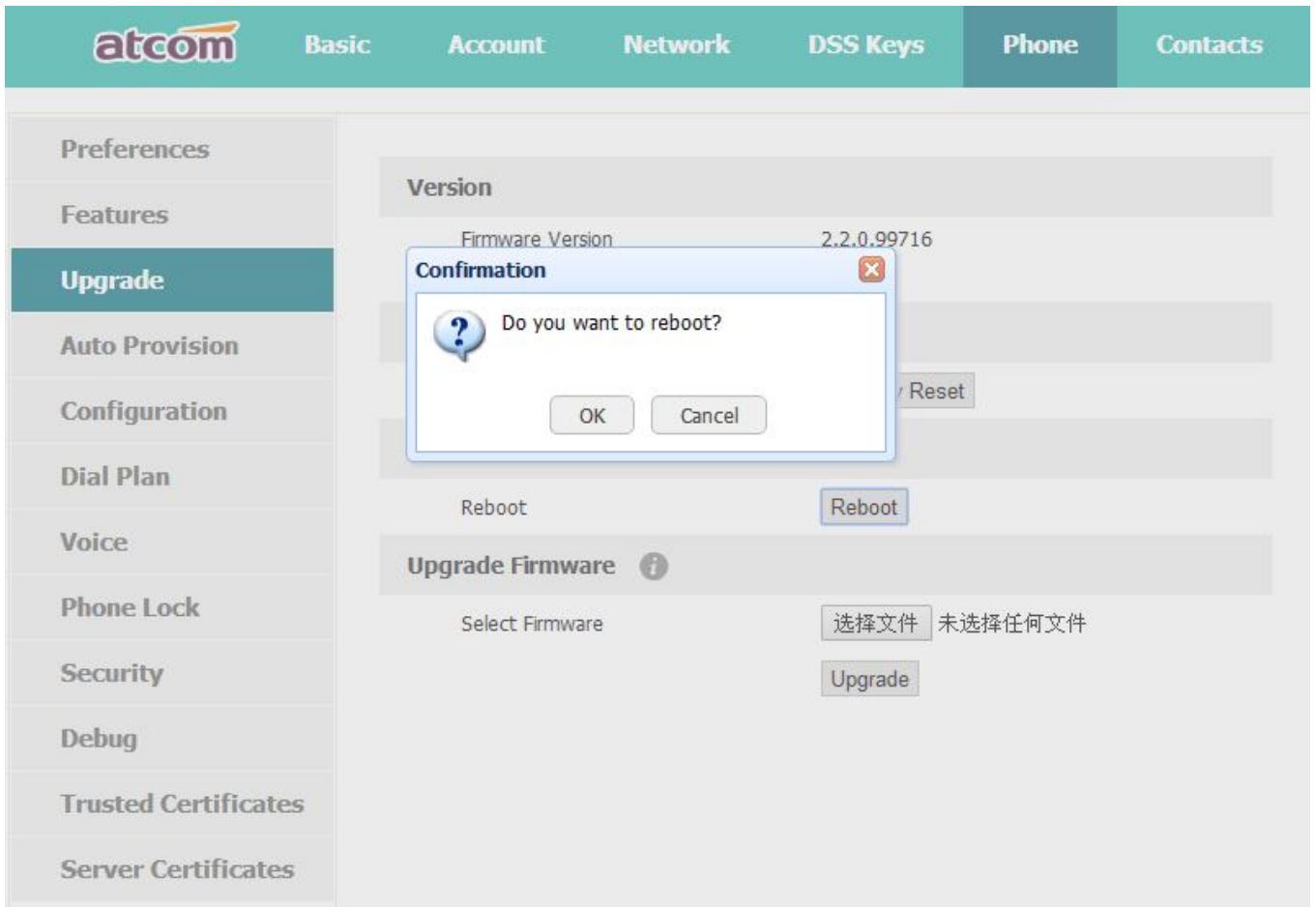

6. Reset to factory

Once reset to factory, all parameter settings will back to the factory default value, and all configure will be cleared, users must be careful on this.

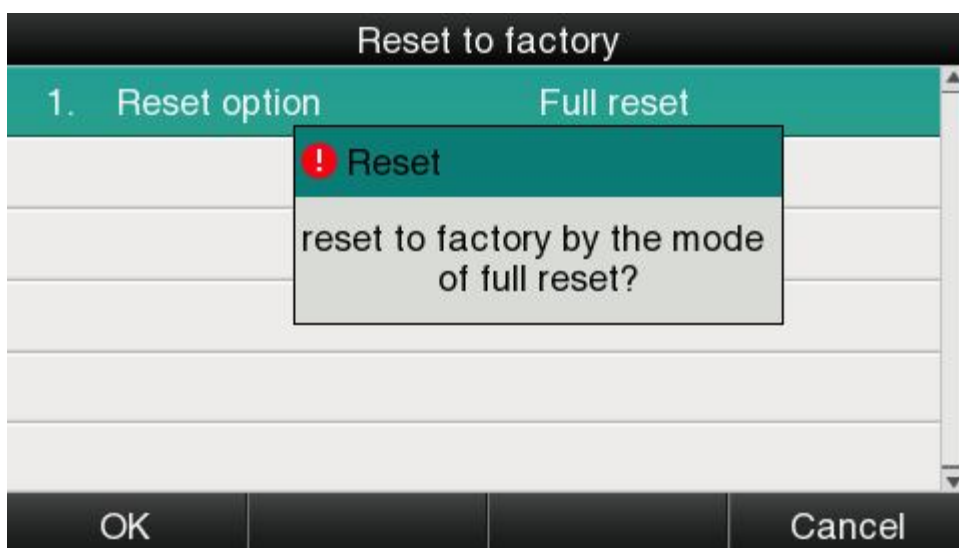

Reset Option: **Full Reset**, **Config Reset** and **UserData Reset**.

Reset to factory via Web: **Phone**→**Upgrade**→**Reset to Factory**.

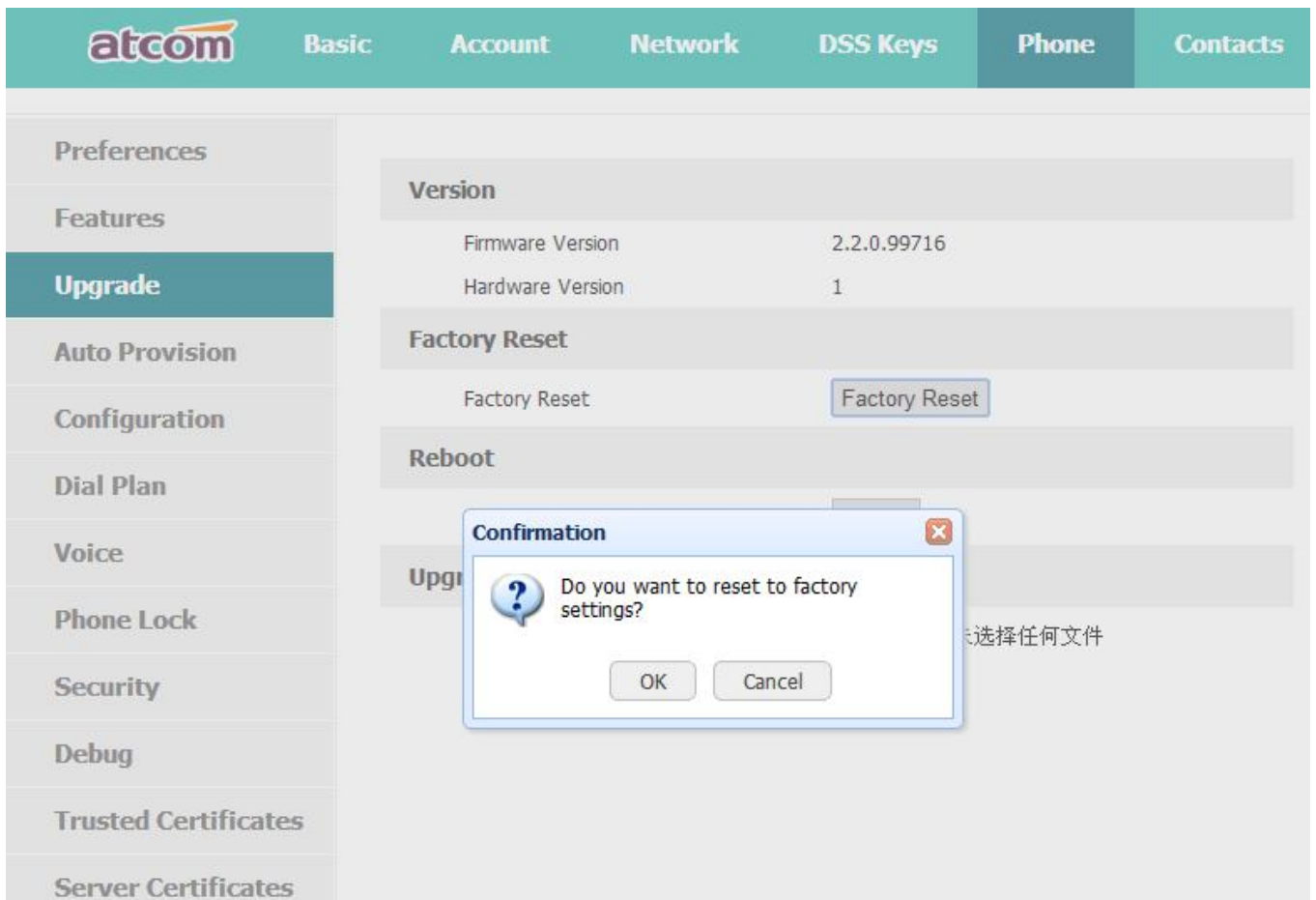



4.7. Display

For more convenient, users are able to adjust the contrast grade and backlight of the main LCD display.



1. Wallpaper

There are 5 different wallpapers for options, press the soft key **"Switch"** or the key 、 for modification.





It support upload custom wallpaper.

The path via web: **Phone→Preferences.**



Wallpaper

2. Slave Contrast

There are 9 different contrast grades for options, press the soft key **Switch** or the key ,  for modification, 6 is the default value.



3. Slave LCD Mode

There are 2 different modes for options, press the soft key **Switch** or the key ,  for modification, defaults to Mode2.



4. Backlight

Backlight is the brightness of LCD, also it has been defined as 9 different grades. The number "9" means the lightest.



To adjust the brightness of LCD expansion module, it must be connected with the hosted phone. Otherwise the host phone will indicate "No expansion module".

5. Screensaver

The phone is not operating within the given time, automatically enter the screensaver interface.



5. Advanced Feature

5.1. Codecs

A68(W) support multiple codecs, users can select the codes via Web.

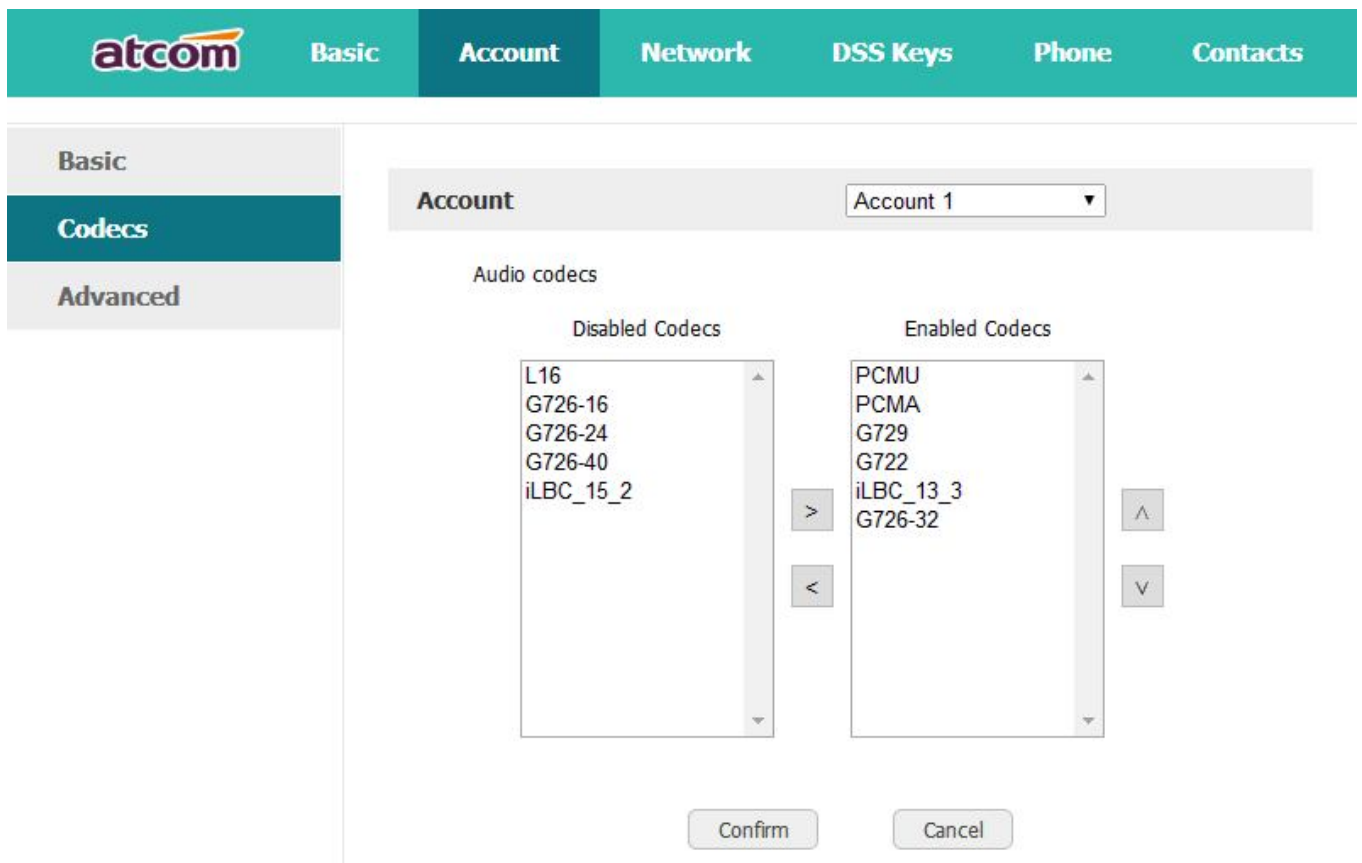

The screenshot shows the 'Account' configuration page for 'Account 1'. The 'Audio codecs' section is active, displaying two columns: 'Disabled Codes' and 'Enabled Codes'. The 'Disabled Codes' list includes L16, G726-16, G726-24, G726-40, and iLBC_15_2. The 'Enabled Codes' list includes PCMU, PCMA, G729, G722, iLBC_13_3, and G726-32. Navigation arrows (> and <) are between the lists, and up/down arrows are on the right of the 'Enabled Codes' list. 'Confirm' and 'Cancel' buttons are at the bottom.

 means to enable the item of “Disabled Codes” ;

 means to disable the item of “Enabled Codes” ;

Click the button  or  to sort all enabled codes, the top item has the highest priority.

Note: Multiple different items of G726, iLBC should not activated simultaneously.

5.2. Capture and Upgrading

Capture package:

It would record the phone current info.

Via webpage: **phone**→**Debug**→**PCAP Feature**

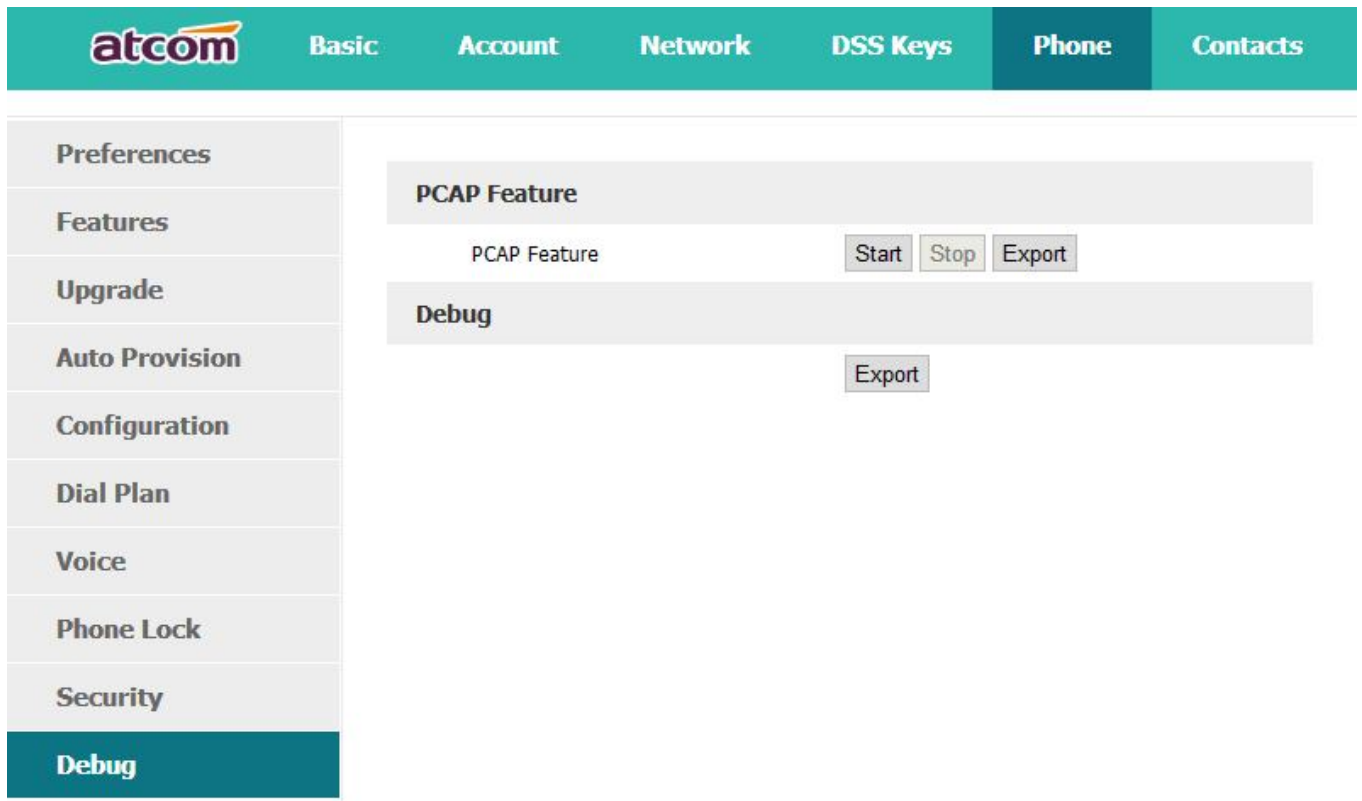

Click the button "Start" to start the capture and click the button "Stop" to end the capture. Then click the button "export" to download the capture file.

Upgrade firmware:

Via webpage: **phone**→**Upgrade**→**Upgrade Firmware**

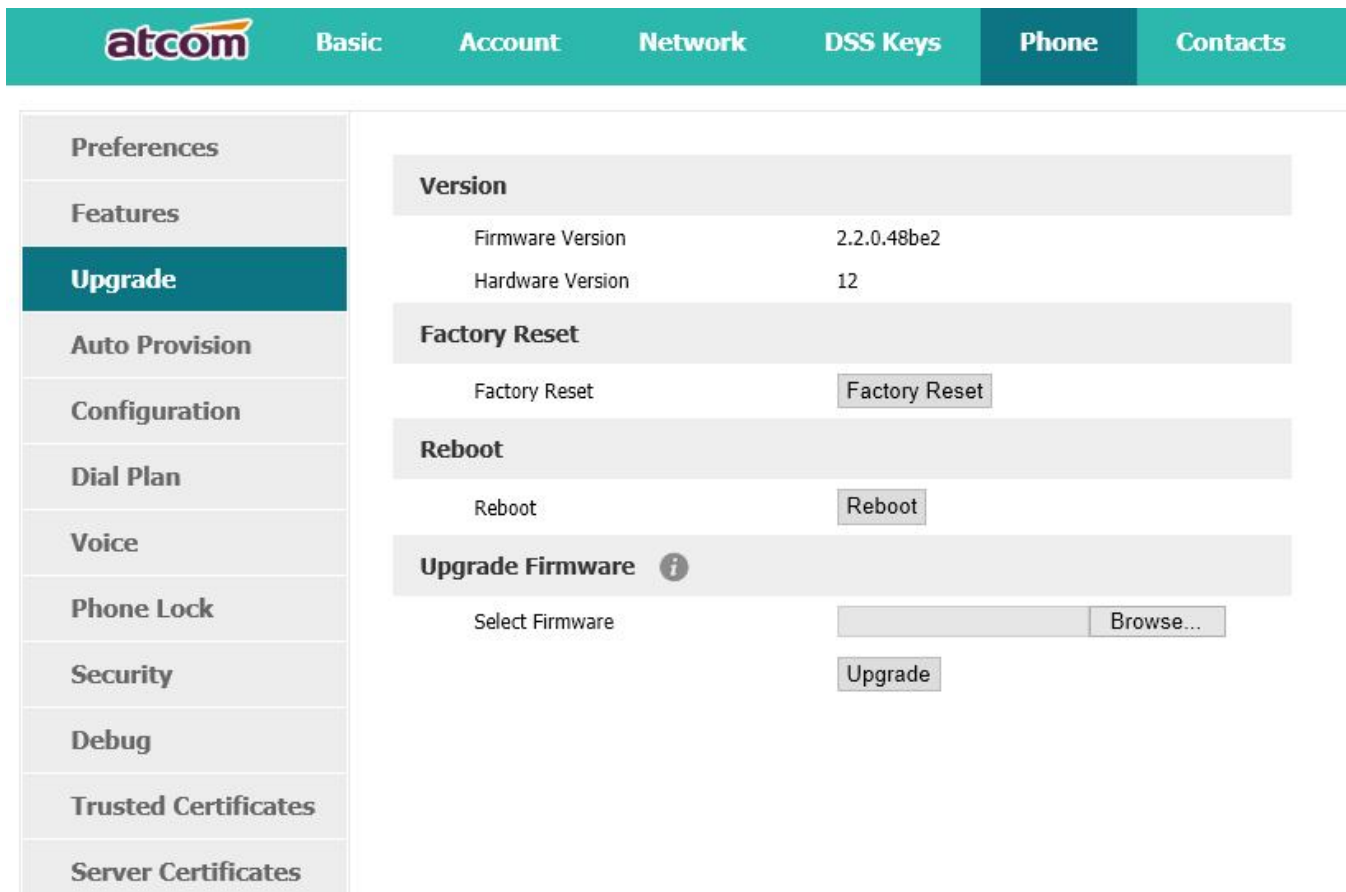

The screenshot shows the atcom web interface with the 'Phone' tab selected. The left sidebar contains a menu with the following items: Preferences, Features, Upgrade (highlighted), Auto Provision, Configuration, Dial Plan, Voice, Phone Lock, Security, Debug, Trusted Certificates, and Server Certificates. The main content area is divided into several sections:

- Version**: Displays Firmware Version (2.2.0.48be2) and Hardware Version (12).
- Factory Reset**: Contains a 'Factory Reset' button.
- Reboot**: Contains a 'Reboot' button.
- Upgrade Firmware**: Includes an information icon, a 'Select Firmware' label, a text input field, a 'Browse...' button, and an 'Upgrade' button.

Before upgrading the firmware of phone, users are suggested to check the version of current firmware. Click the button "Choose file" to select the target local file and click "Upgrade" to process upgrading, this will cost a couple of minutes. And after reboot, the phone will be upgraded successfully.

5.3. Auto Provision

User is able to configure the phone to upgrade automatically.

Preferences	<div style="background-color: #f2f2f2; padding: 5px; margin-bottom: 10px;">Auto Provision</div> <p>PnP Active <input checked="" type="radio"/> On <input type="radio"/> Off i</p> <p>DHCP Active <input checked="" type="radio"/> On <input type="radio"/> Off i</p> <p>Provisioning Server <input style="width: 100%;" type="text"/> i</p> <p>User Name <input style="width: 100%;" type="text"/></p> <p>Password <input style="width: 100%;" type="password"/> i</p> <p>Common AES Key <input style="width: 100%;" type="text"/></p> <p>MAC-Oriented AES Key <input style="width: 100%;" type="text"/></p> <p>Check New Config <input checked="" type="radio"/> On <input type="radio"/> Off i</p> <p>Repeatedly <input type="radio"/> On <input checked="" type="radio"/> Off</p> <p>Interval(minutes) <input style="width: 100%;" type="text" value="1440"/></p> <p>Weekly <input type="radio"/> On <input checked="" type="radio"/> Off</p> <p>Time <input style="width: 100%;" type="text" value="03:00 -- 03:00"/></p> <p><input checked="" type="checkbox"/> Sunday</p> <p><input checked="" type="checkbox"/> Monday</p> <p><input type="checkbox"/> Tuesday</p> <p><input type="checkbox"/> Wednesday</p> <p>Day of week</p>
Features	
Upgrade	
Auto Provision	
Configuration	
Dial Plan	
Voice	
Phone Lock	
Security	
Debug	

Item	Description
PnP Active	Select "On" or "Off" to enable or disable PNP automatic updates
DHCP Active	Select "On" or "Off" to enable or disable DHCP option automatic updates
Provisioning Server	The address to save control file for auto upgrading, it can filled by http, https, tftp and ftp server, for example, tftp://192.168.1.111
User Name	The username to access the file server
Password	The password to access the file server
Common AES Key	Configures the plaintext AES key for decrypting the Common CFG file
MAC-oriented AES KEY	Configures the plaintext AES key for decrypting the MAC-oriented CFG file

Check New Config	If set this parameter as "On", the phone will do some check for upgrading, and it will upgrade automatically once the conditions are met
Repeatedly	If set this parameter as "On", the phone will do some check for upgrading after "Interval(minutes)", and it will upgrade automatically once the conditions are met
Interval(minutes)	This parameter is configurable once the Repeatedly is "On"
Weekly	If set this parameter as "On", the phone will do the check for upgrading at a certain time in every week
Time	The time range that the phone do the check for upgrading every week, and it's configurable once the Repeatedly is "On"
Day of week	The day of week that the phone do the check for upgrading every week, and it's configurable once the Repeatedly is "On"

5.4. Export & Import configuration file

If user wants to set the same configuration on multiple phones, there is an easy way that export the configuration file from one phone and then import this file into other phones. This operation can be completed via Web only.

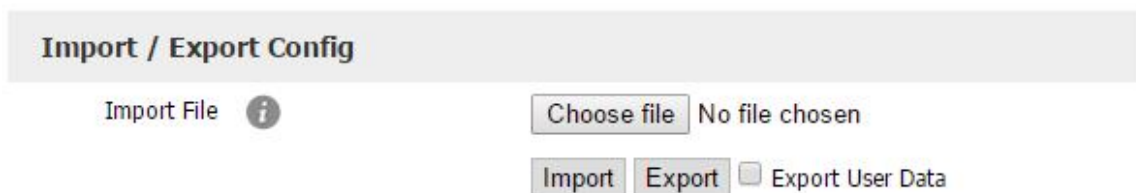

5.4.1. Export configuration file

There is two ways to export the configuration files,

- Don't check the "Export User Data" and click "Export" directly, it will export the template of the configuration file;
- Check the "Export User Data" and then click "Export", it will export a configuration file that carries with user's configured data.

To modify the exported configuration file, you should decompress it until you get a file names as configuration.



Name	Date modified	Size
configuration	2014/10/10 11:14	
config.tar.gz	2014/10/10 11:14	9 KB

The content of configuration file listed as below,

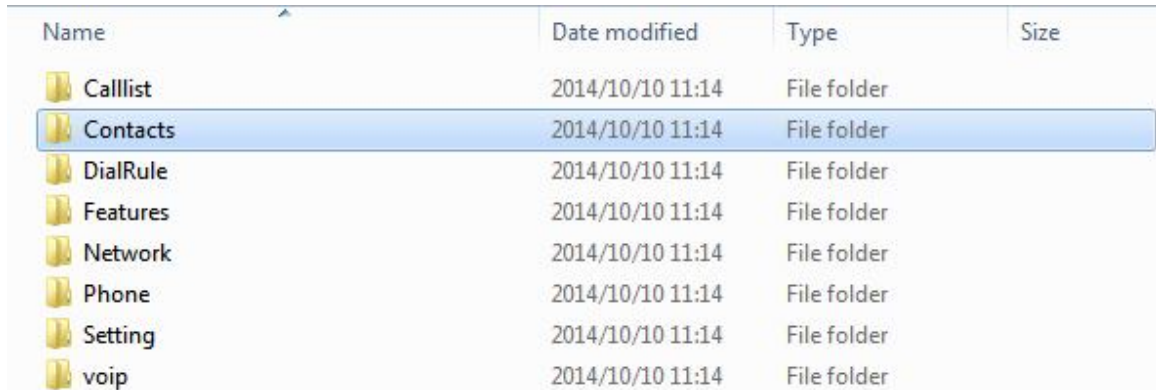

Name	Date modified	Type	Size
Calllist	2014/10/10 11:14	File folder	
Contacts	2014/10/10 11:14	File folder	
DialRule	2014/10/10 11:14	File folder	
Features	2014/10/10 11:14	File folder	
Network	2014/10/10 11:14	File folder	
Phone	2014/10/10 11:14	File folder	
Setting	2014/10/10 11:14	File folder	
voip	2014/10/10 11:14	File folder	

5.4.2. Import configuration file

Click the button "Choose file" to select the target file for importing, and then click the button "Import". The phone will be rebooted a couple of minutes later, and import successfully.

Note: If some part of the configuration file has been modified manually, it must be re-compressed as the format of "tar.gz" in Linux

5.5. Export & Import CFG file

The phone download CFG files includes the provision configure file Common.cfg and MAC.cfg file.



Import/Export CFG File ⓘ

Import/Export CFG File No file selected.

Import CFG file:

It supports import the phone provision configure file, no need server support.

Export CFG file:

It downloads the phone configuration CFG file.

5.6. Export System log

When the phone doesn't working well, System log is the best assistant tools for troubleshooting, all operation details has been recorded. This operation is available via Web only.

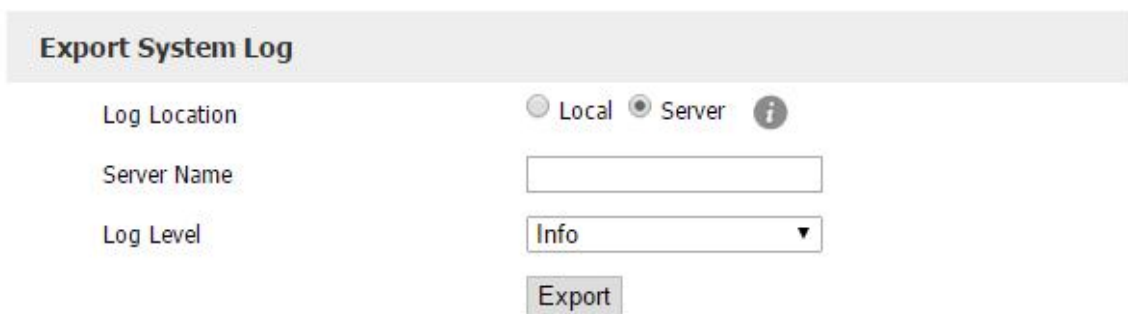

Item	Description
Log Location	You can import the system log to local PC or remote Server.
Server Name	User must fill the address of server if you choose to export the system log to remote server.
Log Level	It defines the detail of system log as 5 different levels, Fatal, Error, Warning, Info, and Debug. The Debug level is the most detailed.

5.7. Dial plan

The customized Dial Plan are available , for example , the rule of replacement, Instant Calling, Area code, Restriction of Outbound.

Before customizing the dial plan, user must learn the basic grammar as below,

.	Represent a character or multiple ones, e.g., "6." can match "66","678","6plus" and so on
x	Represent one character, e.g., "6x" can match "61","62", " 6s" and so on
[]	Represent a character in one range, e.g., " 83[0-5]18618"can match"83018618","83488618" and so on
()	Represent the combination of characters, e.g., "([1-9])([2-7])3" can match "923","153","773" and so on
\$	Add a number after the character "\$" to define the location of the characters, e.g., use the prefix " 8([1-3])(.)" to replace "7\$2", the phone will call "7837" after dialing out "82837"

Note: Any operations (add, modify or delete) on the current dial plan will be not effective until click "Save".

5.7.1. Replace Rule

Dial plan "Replace Rule" means to replace a batch of complicated character string by some simple characters, to make a speed dial.

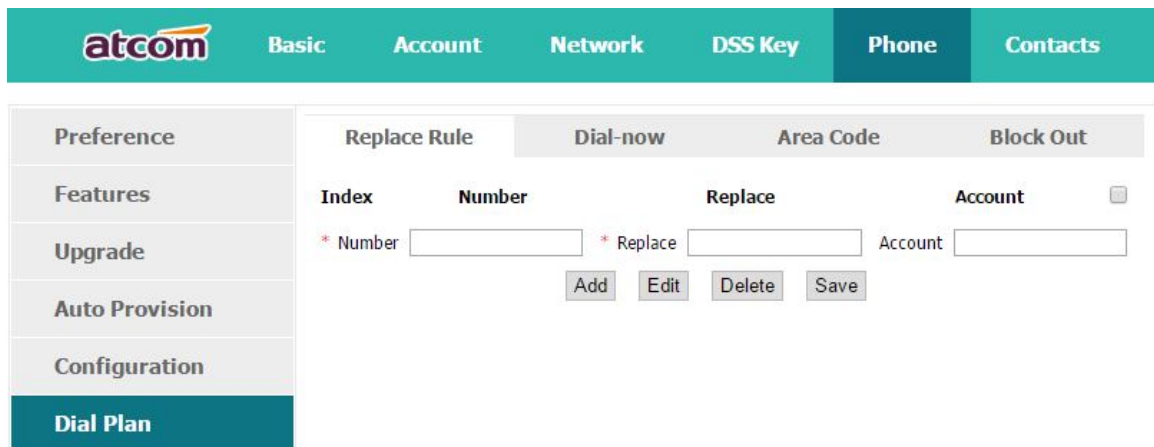

Item	Description	Sample
Number	The string works as replacer, not null	Set Number as "6",
Replace	The string that to be replaced, not null	Set Replace as"6032",
Account	The account to apply this dial plan, blank or 1~4 is valid.	Set Account as "1". It means when dial 6, the

Add	Multiply replace rules can be configured in one phone, after one replace dial plan configured, click this button to add a new one	phone will dial 6032.
Edit	The existed replace dial plans are editable. The specified dial plan should be selected until it is covered with orange and the input fields "Number" and "Replace" shows the details correctly. After modifying, click button "Edit" to make it to be effect	
Delete	Delete one added or saved replace dial plan or multiple ones, click the frame after the specified replace dial plan before delete it, and then click button "Delete"	
Save	Any alteration won't take effect until the button "Save" is clicked.	

5.7.2. Dial-now

Dial plan "Dial-now" permits the corresponding phone to be dialed instantly without pressing the soft key "Dial", once the input has been matched. It works like a hotline.

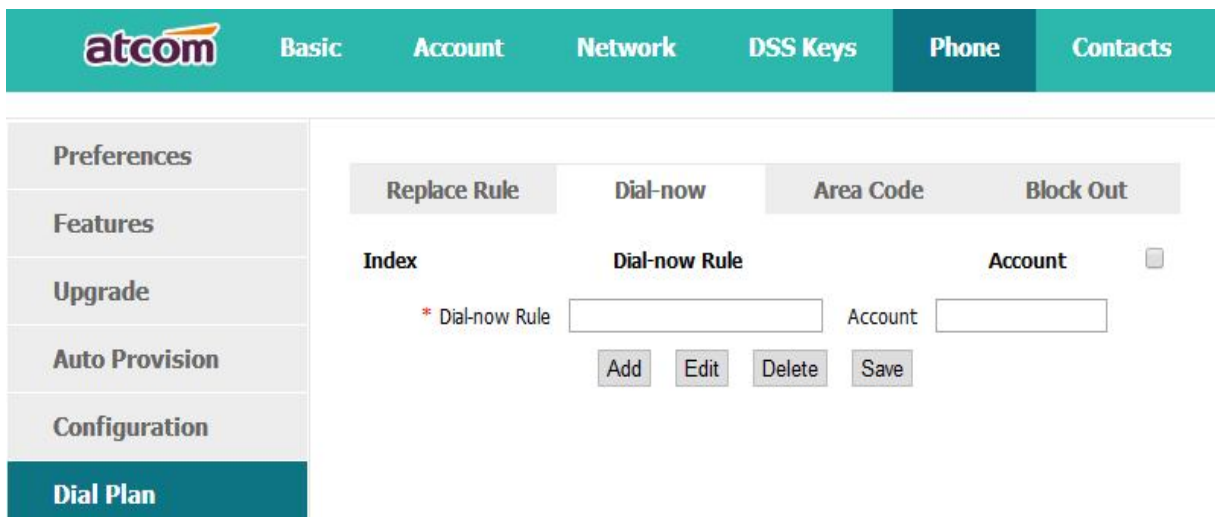

Item	Description	Sample
------	-------------	--------

Dial-now Rule	The string to be dialed out automatically by the phone	Set "Dial-now Rule" as 6xxx, keep "Account" as null It means the phone will use the 1st available account to call 6033 after "Dial-now Time-out" seconds when inputting four figures begin with 6 Note: Dial-now rule is different with hotline. The Dial-now rule will take effect when input numbers matches the dial plan, and hotline takes effect in situation that the phone is in dialing state
Account	The account to apply this dial plan, blank or 1~4 is valid.	
Add	Multiply dial-now rules can be configured in one phone, after one dial-now dial plan configured, click this button to add a new one	
Edit	The existed dial-now dial plans are editable. The specified dial plan should be selected until it is covered with orange and the input fields "Number" and "Dial-now" shows the details correctly. After modifying, click button "Edit" to make it to be effect	
Delete	Delete one added or saved dial-now dial plan or multiple ones, click the frame after the specified dial-now dial plan before delete it, and then click button "Delete"	
Save	Any alteration won't take effect until the button "Save" is clicked.	

Set "Dial-now Time-out" via web: **Phone**→**Features**→**General Information**→**Dial-now Time-out (secs)**.

5.7.3. Area Code

Dial plan "Area Code" has been defined to identify each different area. To call a phone number of other areas, user must add the area code to be in front of the phone number. For convenience, area code has been recommended to be configured while frequently dialing to that type of phone number.

Item	Description	Sample
Code	The area code dialed before the number	Set "Code" as "0086577",
Minimum length	The minimum length of the number input to activate the area code dial plan	Set "Minimum length" as "5".
MA41(w)imum length	The mA41(w)imum length of the number input to activate the area code dial plan	It means when dialing 83018618 with the 5 th account, the phone will dial 0086577 before it.
Account	The account to apply this dial plan, blank or 1 is valid.	Note: If the length of the number input in the dial UI is not between minimum length and the mA41(w)imum length, area code will not take effect
Confirm	Apply this dial plan	
Cancel	Recover all input fields to the state that saved at latest time	

5.7.4. Block Out

Dial plan "Block out" is used to prohibit the phone number outgoing call from some accounts.

Item	Description	Sample
Block Out Number	The number that prohibited	Set "Block Out Number 1" as "10086"
Account	The account to apply this dial plan, blank or 1	It means the phone will enter the "Call End" UI when dial "10086"
Confirm	Apply this dial plan	
Cancel	Recover all input fields to the state that saved at latest time	

5.8. TR069

The TR069 feature is used to remotely manage the devices such as gateways and routers in the general user network from the network side. It mainly includes two types of logical devices: managed user equipment and management server (ACS).

TR069 can remotely configure the phone, upgrade firmware and so on.

atcom

[Basic](#)
[Account](#)
[Network](#)
[DSS Keys](#)
[Phone](#)
[Contacts](#)

DND&Forward

Preferences

Features

Upgrade

Auto Provision

Configuration

Remote Control

Action URL

Tones

Dial Plan

Voice

Phone Lock

TR069

TR069

Enable TR069	<input type="text" value="Enable"/>	▼
ACS URL	<input type="text"/>	i
ACS Username	<input type="text" value="JaN-808287041B0A"/>	i
ACS Password	<input type="password" value="....."/>	
Enable Periodic Inform	<input type="text" value="Enable"/>	▼
Periodic Inform Interval (seconds)	<input type="text" value="3600"/>	
Connection Request Username	<input type="text"/>	i
Connection Request Password	<input type="password"/>	

Item	Description
Enable TR069	It enables or disables the TR069 feature
ACS URL	It configures the access URL of the ACS(Auto Configuration Servers)
ACS Username	It configures the user name for the phone to authenticate with the ACS
ACS Password	It configures the password for the phone to authenticate with the ACS
Enable Periodic Inform	It enables or disables the phone to periodically report its configuration information to the ACS
Periodic Inform Interval(seconds)	the interval 5~4294967295
Connecting Request Username	It configures the user name for the IP phone to authenticate the incoming connection requests
Connecting Request Password	It configures the password for the IP phone to authenticate the incoming connection requests

5.9. Action URL

Action URL allows IP phones to interact with web server applications by sending an http or https GET request.

Mainly used in CTI (Computer Telephony Integration) scene, such as: call center.

Note: For more information, please refer to atcom Action URL and Active URI user manual.

atcom			Basic	Account	Network	DSS Keys	Phone	Contacts
DND&Forward		Setup Completed					<input type="text"/>	
Preferences		Registered					<input type="text"/>	
Features		Unregistered					<input type="text"/>	
Upgrade		Register Failed					<input type="text"/>	
Auto Provision		Off Hook					<input type="text"/>	
Configuration		On Hook					<input type="text"/>	
Remote Control		Incoming Call					<input type="text"/>	
Action URL		Outgoing Call					<input type="text"/>	
Tones		Established					<input type="text"/>	
Dial Plan		Terminated					<input type="text"/>	
Voice		Open DND					<input type="text"/>	
Phone Lock		Close DND					<input type="text"/>	
TR069		Open Always Forward					<input type="text"/>	
Security		Close Always Forward					<input type="text"/>	
Debug		Open Busy Forward					<input type="text"/>	
Trusted Certificates		Close Busy Forward					<input type="text"/>	
		Open NoAnswer Forward					<input type="text"/>	
		Close NoAnswer Forward					<input type="text"/>	
		Transfer Call					<input type="text"/>	
		Blind Transfer					<input type="text"/>	

5.10. Remote Control

Remote control (Active URL) refers to the remote control of the phone for a variety of operations, mainly used in CTI (Computer Telephony Integration) scene,

Such as: call center, the operator on the computer to operate the phone , then make the call, answer the call and other function.

Note: For more information, please refer to atcom Action URL and Active URI user manual.

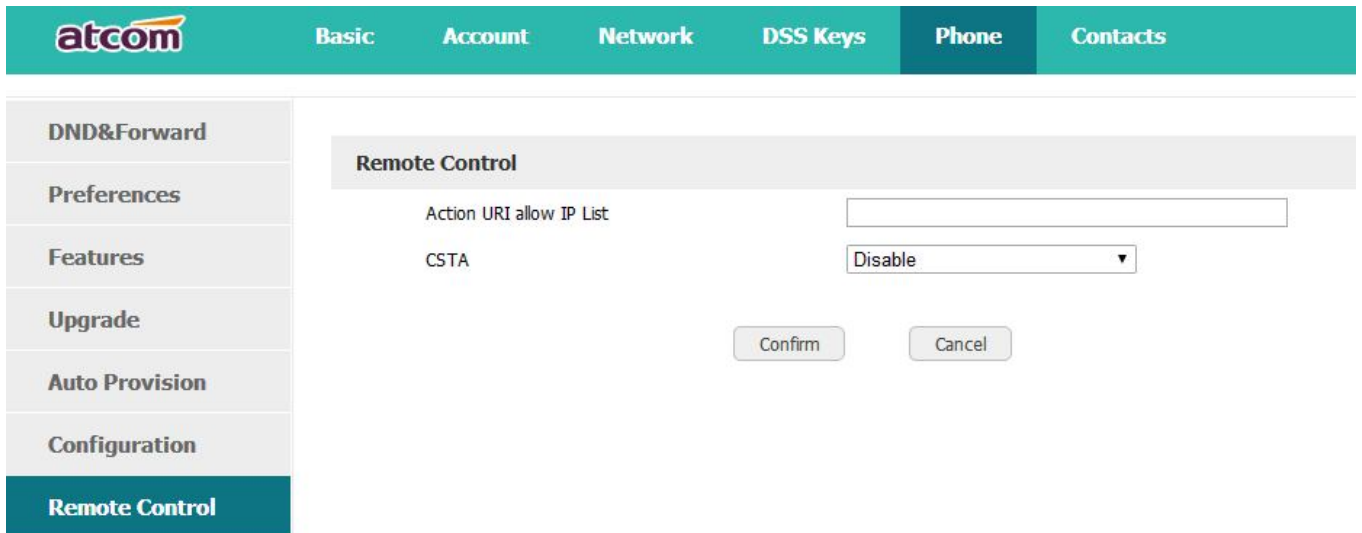

Item	Description
Action URI allow IP list	Input an IP address control phone, such as 172.16.0.235
	Input multiple IP address control phone, use ',' separated, for example: 172.16.0.235,172.16.0.23,172.16.0.15
	Input any, any PC can control the phone, for example: any
CSTA	Will open or close DND & Forward request to the server (needs server support)

6. WI-FI(For A68W and A68WAC)

6.1. Configure the WIFI on the phone

1. Press **"Menu"**→**"WIFI Settings"**→**"Switch"**, open the WIFI connection mode.
2. Please move the navigation key to check the WIFI you want to connect, Press **"Connect"**, then input the correct wifi password.

3. Return to the standby interface, and phone successful connected to the wifi.
4. The last option is Manual setting, press 'Enter', then input the SSID and password.

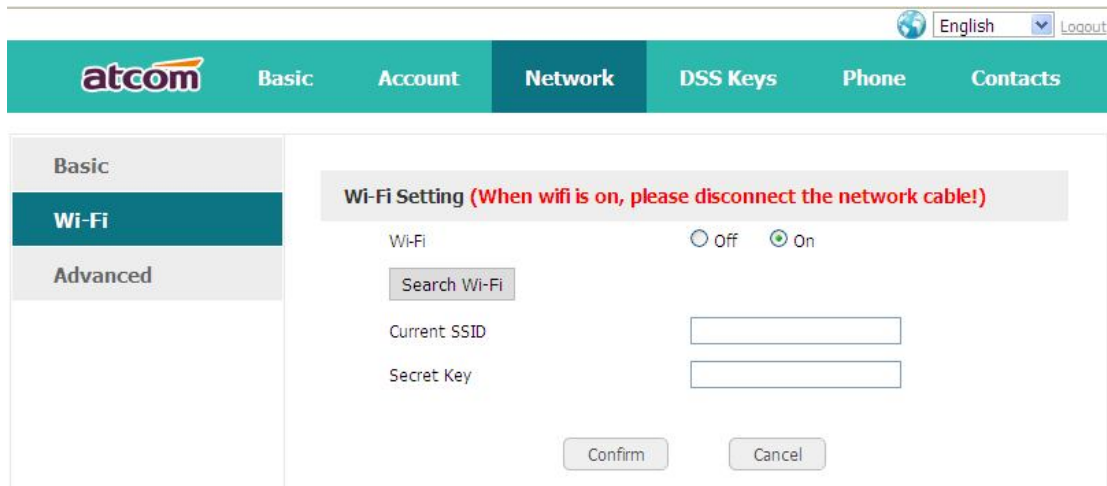

6.2. Configure the WIFI on the WEB

A68W connect to network via Wi-Fi acquiescently, click "Search Wi-Fi" button to search the available Wi-Fi.



After all available Wi-Fi hotspots are list out, click the round behind the available Wi-Fi which you want to connect.

Index	SSID	Signal	Select
1	cisco	211	<input type="radio"/>
2	360	207	<input type="radio"/>
3	re	207	<input type="radio"/>
4	amoji	205	<input type="radio"/>
5	CHINA TELECOM	205	<input type="radio"/>
6	360_____WIFI-C9	197	<input type="radio"/>
7	_____	197	<input type="radio"/>
8	_____	190	<input type="radio"/>
9	inWatch3	189	<input type="radio"/>
10	ChinaNet-7A6t	188	<input type="radio"/>
11	360_____WIFI-9F	185	<input type="radio"/>
12	iTV-7A6t	185	<input type="radio"/>
13	inWatch2	185	<input type="radio"/>
14	Royale International China	184	<input type="radio"/>

Input the right "Secret Key" and then click the "Confirm" button, the phone will reboot, after rebooting, the Wi-Fi icon will display on the home screen, it means connect failed when the icon come with , then you should check the configuration. if the icon come with , it means connect successfully.

6.3. Enterprise WiFi

It supports WPA/WPA2 Enterprise wifi , it is based on Radius sever and configuration the Enterprise wifi in the router.

Configure the Enterprise wifi:

1. Upload the Certificates

Via the webpage: "**Phone**"→"**Trusted Certificates**"

Index	Issued To	Issued By	Expiration	Delete
0				<input type="checkbox"/>

Import Trusted Certificates

Load trusted certificates file

2. Input the WIFI account info

Via the webpage: "**Phone**"→"**Network**"→ "**WIFI**"

Press the "Search WIFI", and select the SSID, then input the radius ID and password.

Via the phone:

Press "**Menu**"→"**WIFISettings**", and select the SSID , then input the radius ID and password.

7. FAQ

7.1. How to reset to factory

There are 3 methods for factory reset:

1. Factory reset via phone:

- a) Press the key 
- b) Select "Settings", then press the soft key "Enter"
- c) Select "Advanced Settings", then press the soft key "Enter"
- d) Input the access password, then press the soft key "Enter"
- e) Select "Reset to factory", then press the soft key "Enter"
- f) Press the soft key "OK", then the phone will be reboot and resumed to factory default settings

2. Factory reset via Web:

- a) Key in the IP address of phone with a browser,
- b) Access the webpage of phone as the role of "admin", username/password is admin/admin.
- c) Select "Phone"
- d) Select "Upgrade"
- e) Click the button "Reset to Factory"
- f) Click the button "OK"

3. Factory reset during starting:

- a) Hold the key "*" and "#" while power on for 5 seconds
- b) The phone will be reboot and resumed to factory default setting

7.2. Upgrade the firmware on safe mode

If the phone can't be started successfully, user is able to upgrade the firmware on post mode,

- a) Setup a TFTP Server and set the PC's IP address as "192.168.1.200"
- b) Copy the kernel file we supplied to the root menu of TFTP Server
- c) Ensure the TFTP Server and phone are connected to the same network switch and both reachable
- d) Long Press the key "*" and "1" to upgrade the kernel file, and then plug in power until upgrading information displayed on LCD
- e) The phone will start downloading file from TFTP server
- f) After downloading completed, the phone will be automatically upgraded
- g) After upgrading completed, the phone will be started with the factory default settings

7.3. How to make IP call

1. Press it in dialing status
2. To make a IP peer to peer call

Switch the input type to '1aA', then press '*' key to choose '.'. For example, to dial "192.168.1.100":

1. Change to '1aA' input method;
 2. input "192","*", "168", "*", "1", "*", "100"
3. Disable the IP call feature

Via webpage modify the make IP call feature:

Phone→Feature →Accept SIP Trust Server Only, press "Enable".

- Preferences
- Features**
- Upgrade
- Auto Provision
- Configuration
- Dial Plan
- Voice
- Phone Lock
- Security
- Debug
- Trusted Certificates
- Server Certificates

+ Call Forward ⓘ

+ Do Not Disturb

- General Information

Inter Digit Time(secs)	<input type="text" value="8"/>	(1~14) ⓘ
Auto Answer	<input type="text" value="Disabled"/>	ⓘ
Call Waiting	<input type="text" value="Enabled"/>	ⓘ
Hotline	<input type="text"/>	ⓘ
Hotline Time-out(0~180 secs)	<input type="text" value="4"/>	ⓘ
Key As Send	<input type="text" value="#"/>	ⓘ
Dial-now Time-out(secs)	<input type="text" value="1"/>	ⓘ
Busy Tone Timer(secs)	<input type="text" value="0"/>	ⓘ
Return Code When Refuse	<input type="text" value="486 (Busy here)"/>	ⓘ
Return Code When DND	<input type="text" value="480 (Temporarily not a"/>	ⓘ
RFC 2543 Hold	<input type="text" value="Enabled"/>	ⓘ
Use Outbound Proxy in Dialog	<input type="text" value="Disabled"/>	ⓘ
Login Time-out(1~1000 minutes)	<input type="text" value="10"/>	ⓘ
Hide DTMF	<input type="text" value="Disabled"/>	
Watch Dog	<input type="text" value="Enabled"/>	
Accept SIP Trust Server Only	<input type="text" value="Enabled"/>	

8. Troubleshooting

8.1. The phone is failed to register to SIP server

1. First of all, check the IP address. If the LAN port is DHCP, please ensure the DHCP server has been enabled.
2. Check the network gateway
3. Check the DNS
4. Make sure the input account matched the one provided by Service Provider
5. Make sure SIP Server has been enabled already
6. Make sure the Port of SIP Server, it's 5060 by default

8.2. The phone is failed to gain IP address

1. Make sure the network cable has been plugged into the LAN port
2. Make sure the network cable or port of network switch are working fine,
3. Make sure the DHCP server has been enabled, and there are available IP address
4. Try to set the LAN port as Statics IP

8.3. Only one party can hear from another on calling

1. Try to make a IP peer to peer call, to make sure the mic and speaker are working fine
2. Enable STUN via Web
3. Set the address of STUN Server, for example stun.sipgate.com
4. Present this operation above and the phone will be reboot
5. Try to make a normal call again

9. Abbreviation

DND: Do Not Disturb

CFWD: Call Forward

Bxfer: Blind Transfer

Conf: Conference

Num: Number

SIP: Session Initiate Protocol

RTP: Real-time Transport Protocol

SDP: Session Description Protocol

VPN: Virtual Private Network

VLAN: Virtual Local Area Network

QoS: Quality of Service

Syslog: System log

UDP: User Data Protocol

TCP: Transmission Control Protocol

TLS: Transport Layer Security Protocol

BLF: Busy Lamp Field

DNS: Domain Name System

SRTP: Secure Real-time Transport Protocol

NTP: Network Time Protocol

VAD: Voice Activity Detection

CNG: Comfort Noise Generator

10. FCC Caution

Any Changes or modifications not expressly approved by the party responsible for compliance could void the user's authority to operate the equipment.

The device complies with part 15 of the FCC Rules. Operation is subject to the following two conditions: (1) The device may not cause harmful interference, (2) the device must accept any interference received, including interference that may cause undesired operation.

Note: This equipment has been tested and found to comply with the limits for a Class B digital device, Pursuant to part 15 of the FCC Rules. These limits are designed to provide reasonable protection, uses and can radiate radio frequency energy, and if not installed and used in accordance with the instructions, may cause harmful interference to radio communication. However, there is no guarantee that interference will not occur in a particular installation. If this equipment does cause harmful interference to radio or reception, which can be determined by turning the equipment off and on, the user is encouraged to try to correct the interference by one or more of the following measures:

- Reorient or relocate the receiving antenna.
- Increase the separation between the equipment and receiver.
- Connect the equipment into an outlet on a circuit different from that to which the receiver is connected.
- Consult the dealer or an experienced radio/TV technician for help.